

# Historischer Rückblick

---

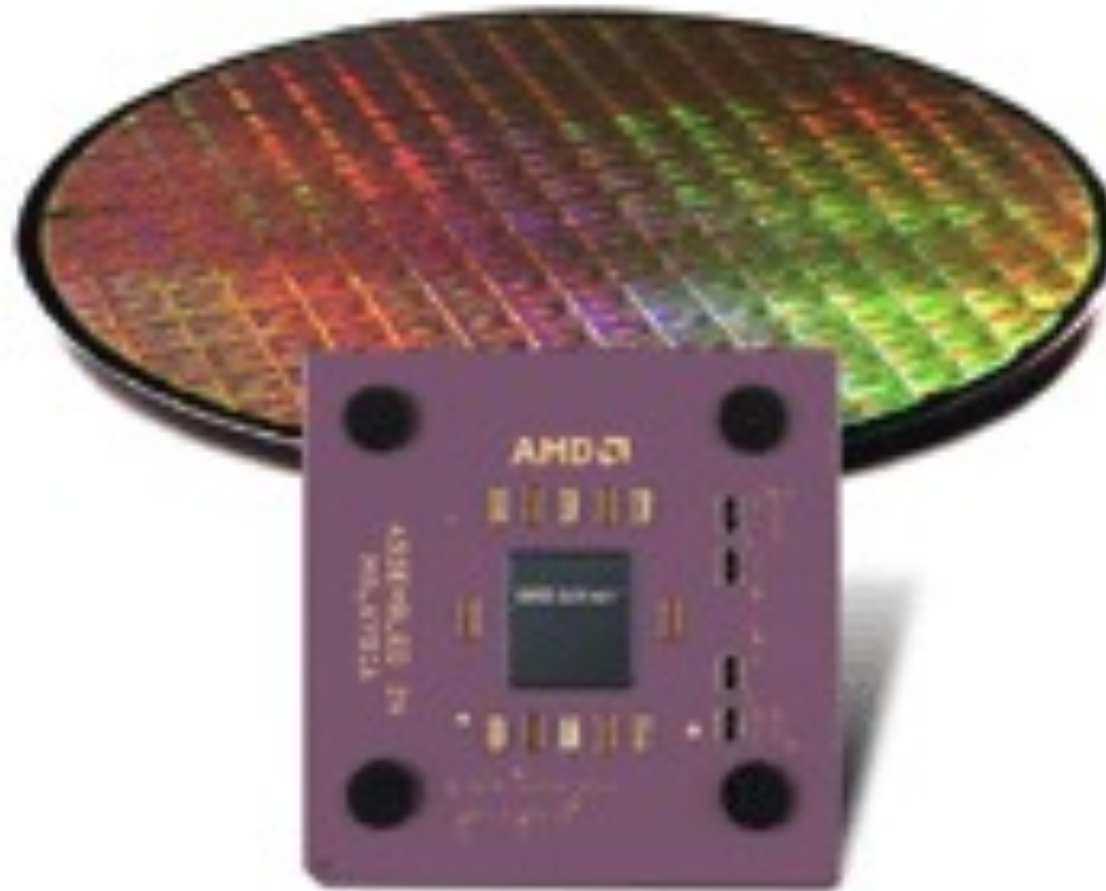

Die Entwicklung der Technik, die Produkte, die Firmen, die Leute, ...

# 1947 – Der erste Transistor

- 'Point Contact Transistor' aus **Germanium**
- **AT&T Bell Laboratories:** William Shockley ↔ Walter **Brattain** and John Bardeen
- 1956: Nobelpreis in Physik für die drei

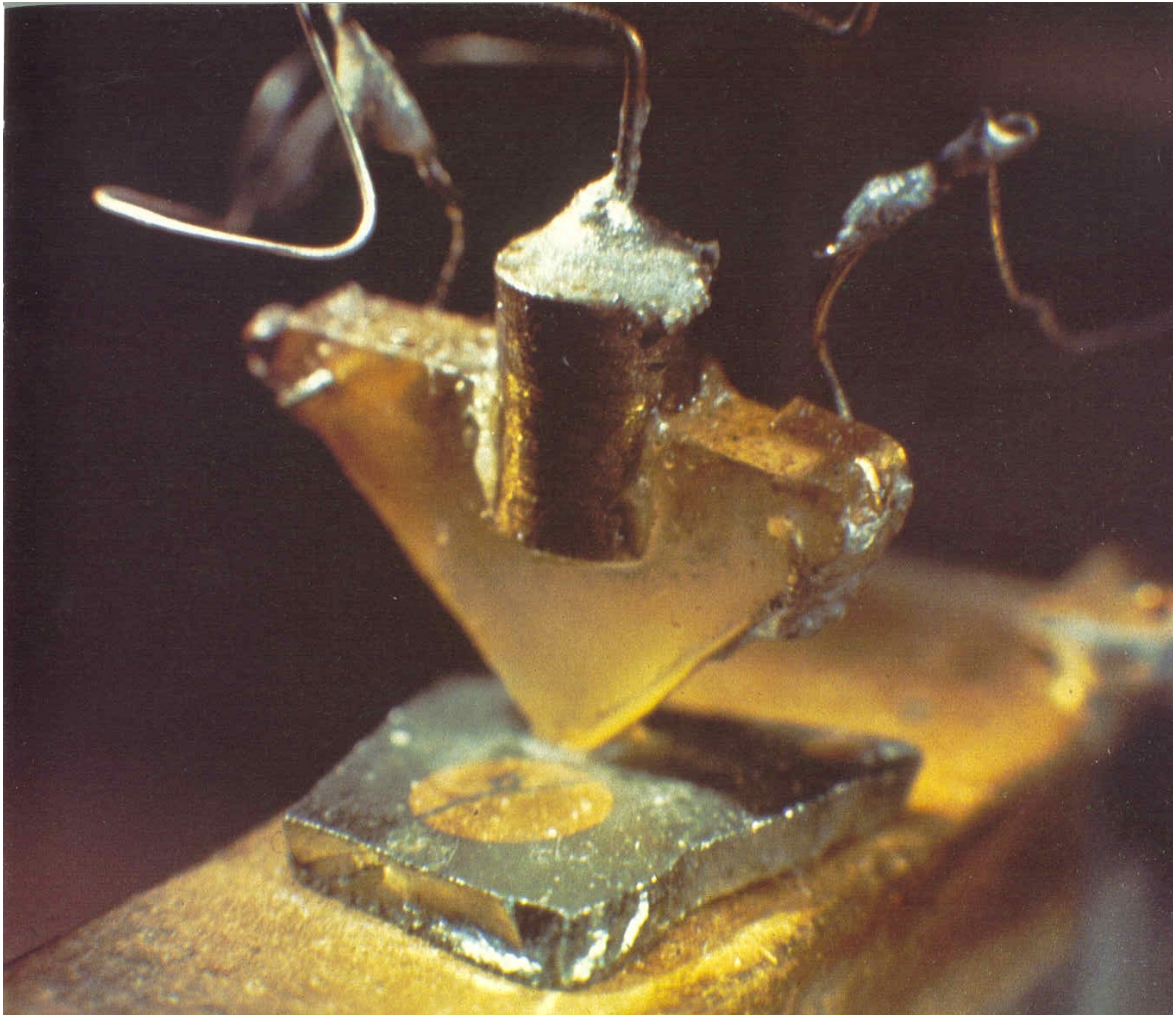

'famous picture'

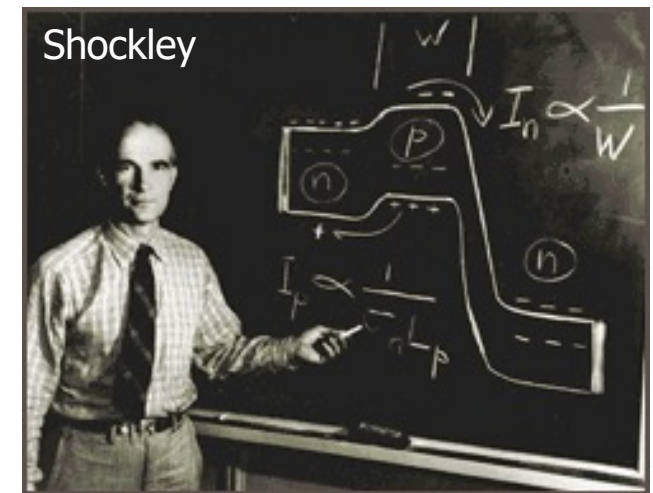

Shockley

# Wann war was ?

---

- Logarithmus John Napier (1550 - 1617)
- Taylorreihe Brook Tailor (1685 - 1731)
- Fourier Transformation? Jean Baptiste Joseph Fourier (1768 – 1830), Zeitgenosse Napoleons
  
- 2 (Nachkomma)-Stellen von  $\pi$  Archimedes, 287-121 v. Chr.
- 7 Stellen Zu Chongzhi (China), ~480
- 35 Stellen Ludolph van Ceulen, 1596
- 100 Stellen John Machin, 1706
- 1000 Stellen ENIAC, 1949
  
- Allgemeine Relativitätstheorie Einstein, 1915
  
- Magnetische Induktion Michael Faraday, 1831
- Kathodenstrahlröhre Karl Ferdinand Braun, 1897
  
- Schwefelsäure Albertus Magnus, 1200-1280
- Uran Martin Heinrich Klaproth 1789 (Oxid)
  
- Radioaktivität Antoine Henri Becquerel, 1896

# Die Vakuumröhre - Diode

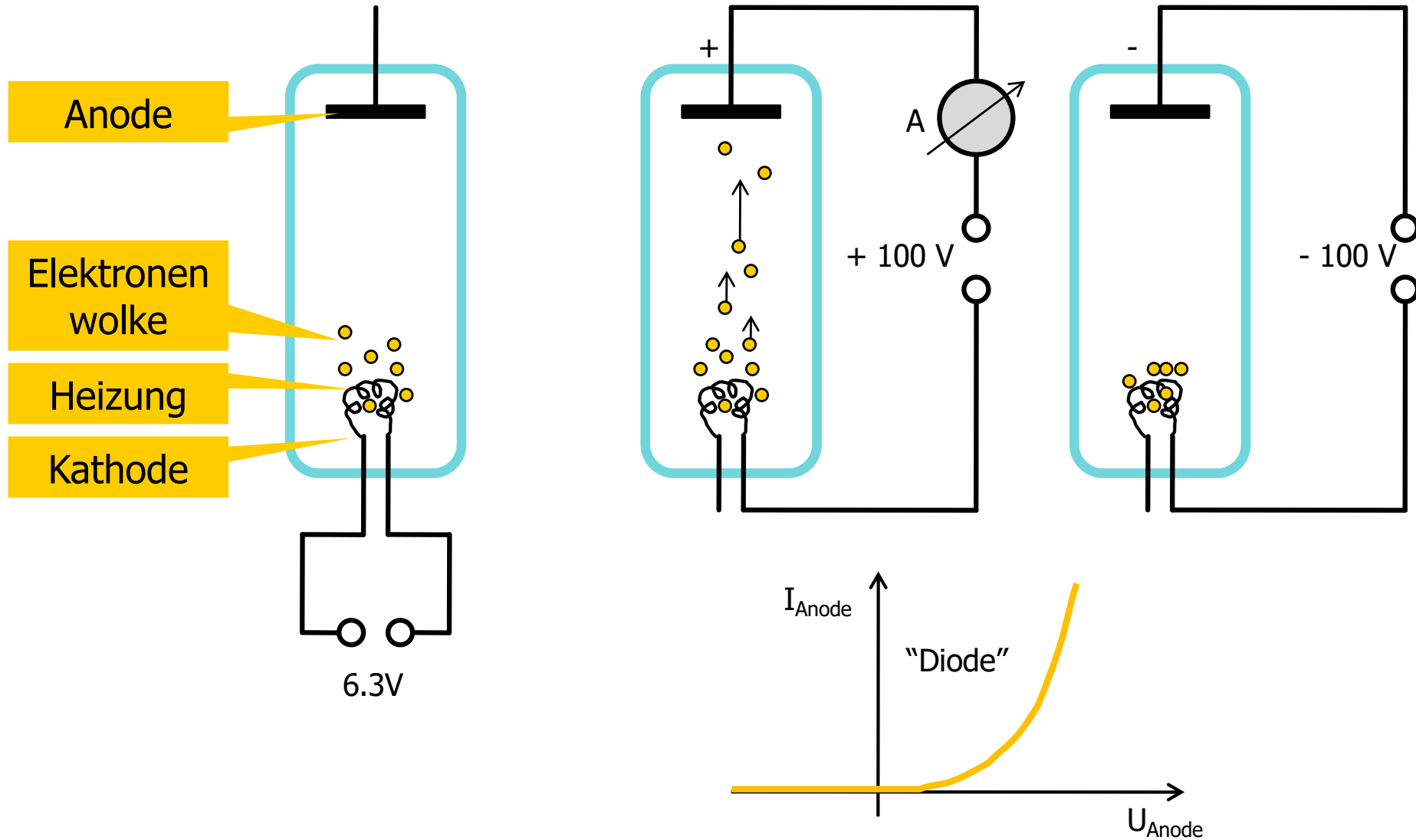



# Die Vakuumröhre - Triode

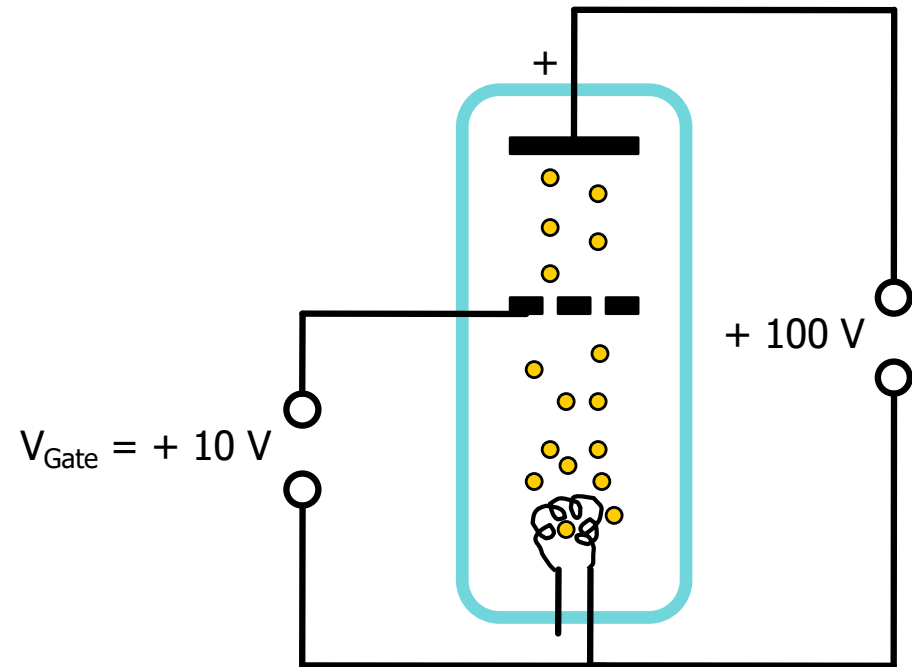
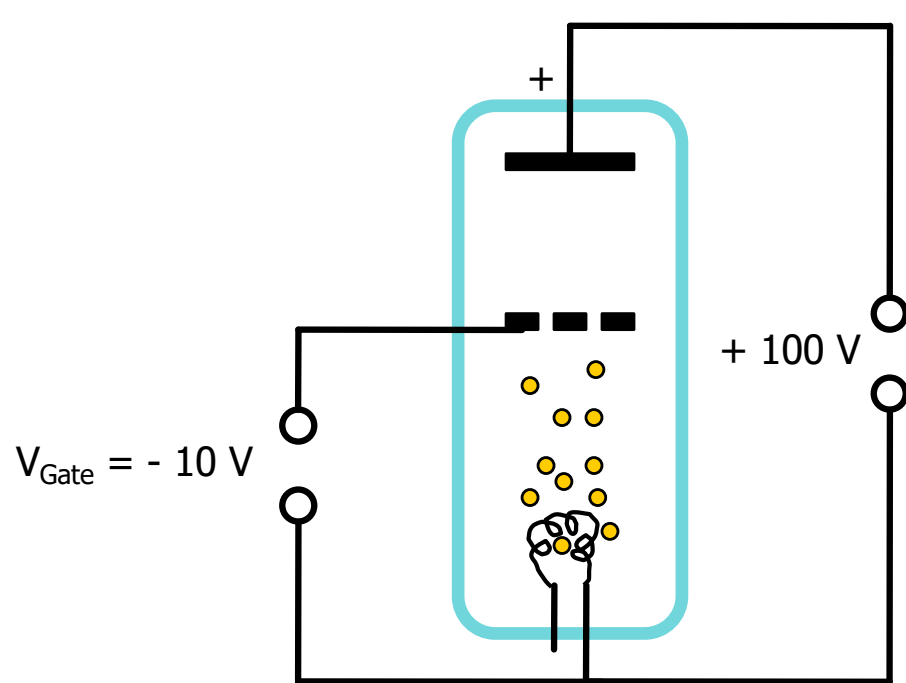

- Strom wird über  $V_{\text{Gate}}$  ein / aus geschaltet
- Bei gegebenem  $V_{\text{Gate}}$  ist Anodenstrom  $\sim$  Gatestrom

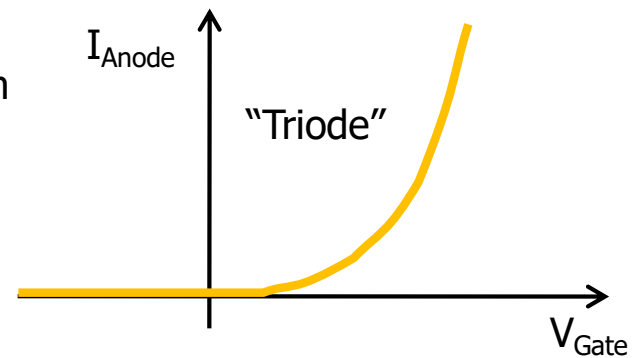

# Vakuumpipen

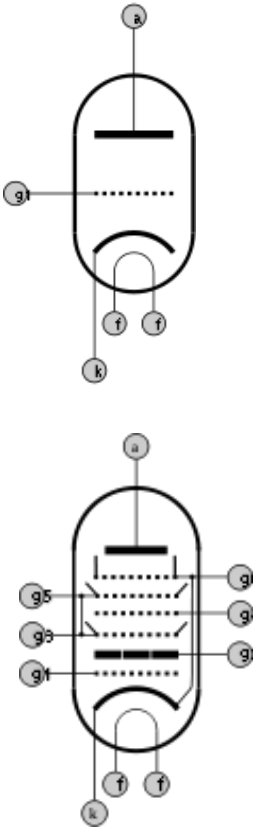

# Patentschrift des Transistors

Patented Oct. 3, 1950 2,524,035

**UNITED STATES PATENT OFFICE**

2,524,035

**THREE-ELECTRODE CIRCUIT ELEMENT  
UTILIZING SEMICONDUCTIVE MATERIALS**

John Bardeen, Summit, and Walter H. Brattain,  
Morristown, N. J., assignors to Bell Telephone  
Laboratories, Incorporated, New York, N. Y., a  
corporation of New York

Application June 17, 1948, Serial No. 33,466  
40 Claims. (Cl. 179-171)

**1** This application is a continuation-in-part of application Serial No. 11,165, filed February 26, 1948, and thereafter abandoned.

This invention relates to a novel method of and means for translating electrical variations for such purposes as amplification, wave generation, and the like.

The principal object of the invention is to amplify or otherwise translate electric signals or variations by use of compact, simple, and rugged apparatus of novel type.

Another object is to provide a circuit element for use as an amplifier or the like which does not require a heated thermionic cathode for its operation, and which therefore is immediately operative when turned on. A related object is to provide such a circuit element which requires no evacuated or gas-filled envelope.

Attempts have been made in the past to convert solid rectifiers utilizing selenium, copper sulfide, or other semi-conductive materials into amplifiers by the direct expedient of embedding a grid-like electrode in a dielectric layer disposed between the cathode and the anode of the rectifier. The grid is supposed, by exerting an electric force at the surface of the cathode, to modify its emission and so alter the cathode-anode current. As a practical matter it is impossible to embed a grid in a layer which is so thick as to insulate the grid from the other electrodes and yet so thin as to permit current to flow between them. It has also been proposed to pass a current from end to end of a strip of homogeneous isotropic semiconductive material and, by the application of a strong transverse electrostatic field, to control the resistance of the strip, and hence the current through it.

So far as is known, all of such past devices are beyond human skill to fabricate with the fineness necessary to produce amplification. In any event they do not appear to have been commercially successful.

It is well known that in semiconductors there are two types of carriers of electricity which differ in the signs of the effective mobile charges. The negative carriers are excess electrons which are free to move, and are denoted by the term conduction electrons or simply electrons. The positive carriers are missing or defect "electrons," and are denoted by the term "holes." The conductivity of a semiconductor is called excess or defect, or N or P type, depending on whether the mobile charges normally present in excess in the material under equilibrium conditions are electrons (Negative carriers) or holes (Positive carriers).

**2** When a metal electrode is placed in contact with a semiconductor and a potential difference is applied across the junction, the magnitude of the current which flows often depends on the sign as well as on the magnitude of the potential. A junction of this sort is called a rectifying contact. If the contact is made to an N-type semiconductor, the direction of easy current flow is that in which the semiconductor is negative with respect to the electrode. With a P-type semiconductor, the direction of easy flow is that in which the semiconductor is positive. A similar rectifying contact exists at the boundary between two semiconductors of opposite conductivity types.

This boundary may separate two semiconductor materials of different constitutions, or it may separate zones or regions, within a body of semiconductor material which is chemically and stoichiometrically uniform, which exhibit different conductivity characteristics.

The present invention in one form utilizes a block of semiconductor material on which three electrodes are placed. One of these, termed the collector, makes rectifier contact with the body of the block. The other, termed the emitter, preferably makes rectifier contact with the body of the block also. The third electrode, which may be designated the base electrode, preferably makes a low resistance contact with the body of the block. When operated as an amplifier, the emitter is normally biased in the direction of easy current flow with respect to the body of the semiconductor block. The nature of the emitter electrode and of that portion of the semiconductor which is in the immediate neighborhood of the electrode contact is such that a substantial fraction of the current from this electrode is carried by charges whose signs are opposite to the signs of the mobile charges normally in excess in the body of the semiconductor. The collector is biased in the reverse, or high resistance direction relative to the body of the semiconductor. In the absence of the emitter, the current to the collector flows exclusively from the base electrode and is impeded by the high resistance of this collector contact. The sign of the collector bias potential is such as to attract the carriers of opposite sign which come from the emitter. The collector is so disposed in relation to the emitter that a large fraction of the emitter current enters the collector. The fraction depends in part on the geometrical disposition of the electrodes and in part on the bias potentials applied. As the emitter is biased in the direction of easy flow, the emitter current

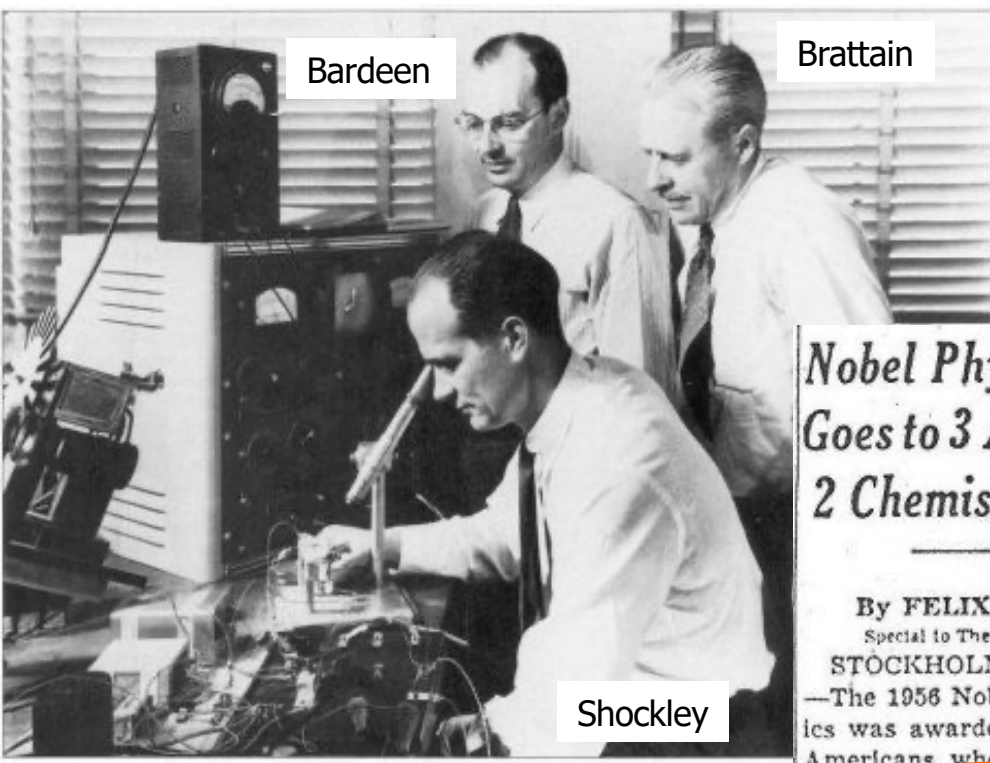

## Nobel Physics Prize Goes to 3 Americans; 2 Chemists Honored

By FELIX BELAIR Jr.  
Special to The New York Times.

STOCKHOLM, Sweden, Nov. 1 —The 1956 Nobel Prize in Physics was awarded today to three Americans who had worked as a team in developing the transistor. This is a tiny and highly efficient substitute for the vacuum tube in electronics.

The prize winners are Dr. William Shockley, the team captain; Dr. Walter H. Brattain and Dr. John Bardeen. The three, who did their work as research scientists of the Bell Laboratories of Murray Hill, N. J., will share the award of about \$38,700 made under the terms of the will of Alfred Nobel, the Swedish inventor of dynamite.



# 1954 – Erstes 'Pocket Radio'

- Texas Instruments:  
"To sell a pocket radio at that point, it was our opinion that it would have to list at \$50," Jonsso recalled. But **four transistors** times **\$16** wouldn't do it, so we had to design a manufacturing process so much better than any other at the time we could sell them for **\$2.50** each. We figured if we could get \$10 for four transistors, the manufacturer could put the rest of the parts together for \$17 or \$18, sell a \$50 radio, and still have a little left over for himself after paying a dealer. Well, we came up with the technique, and **Regency** bought the idea, and that radio went on the market at \$49.95."
- Design-Optimierung: Ein Radio aus 4 Transistoren!

'Regency'

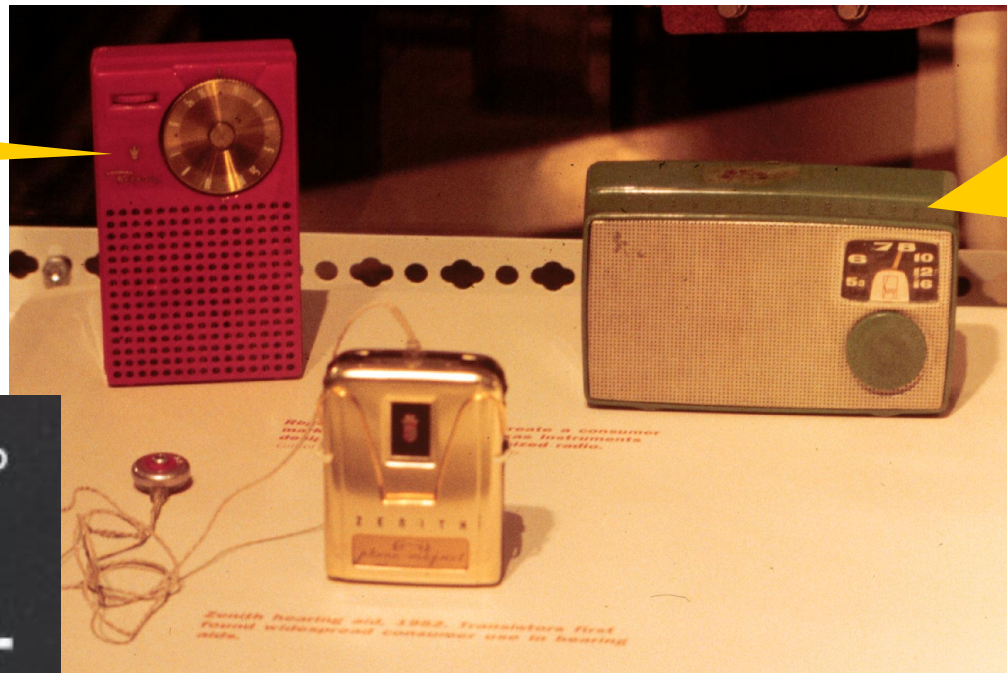

1957:  
Konkurrenz  
von **SONY**.  
Verkauft  
sich viel  
besser.



# Regency: Innenleben

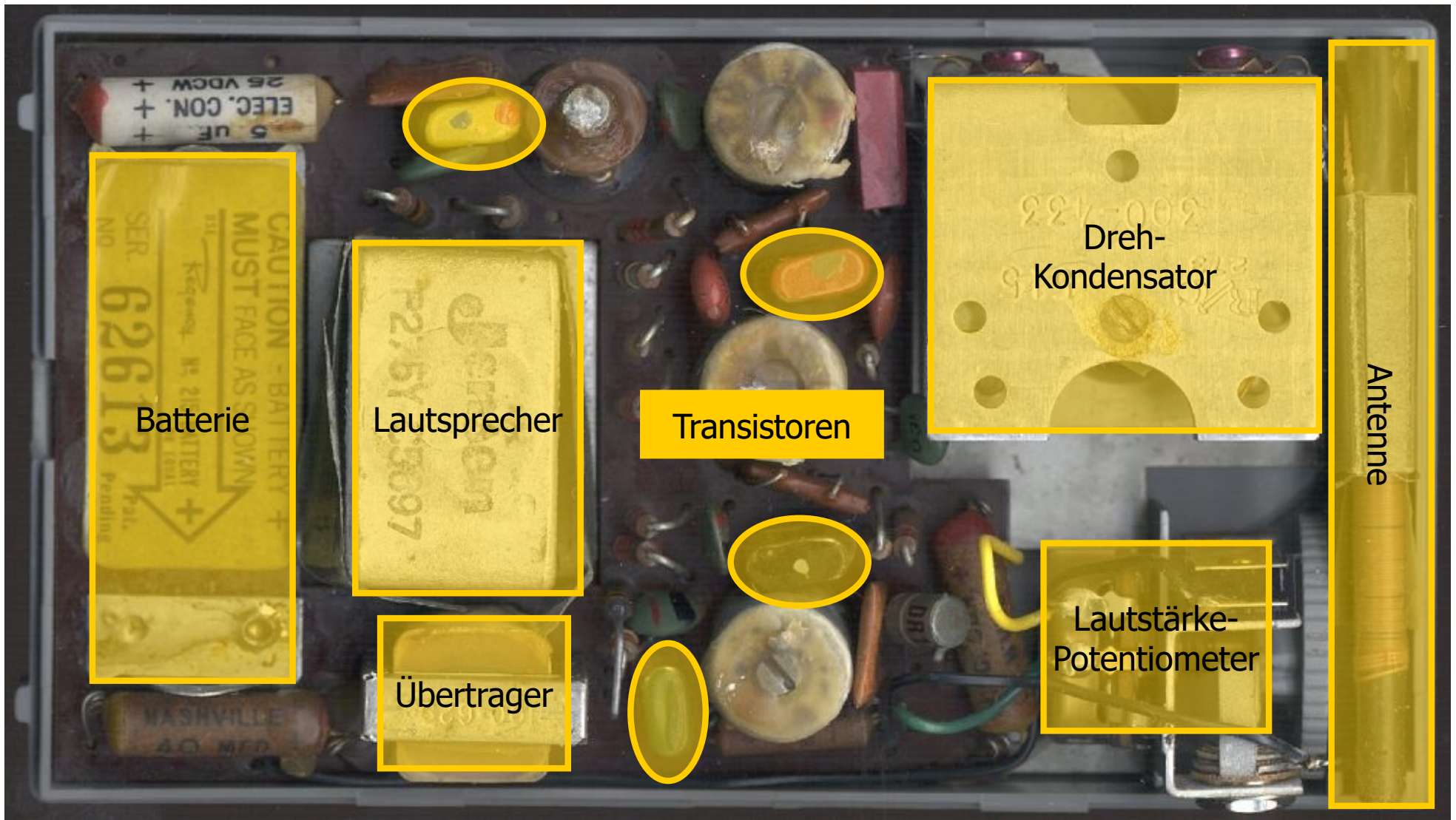



# Regency: Schaltplan

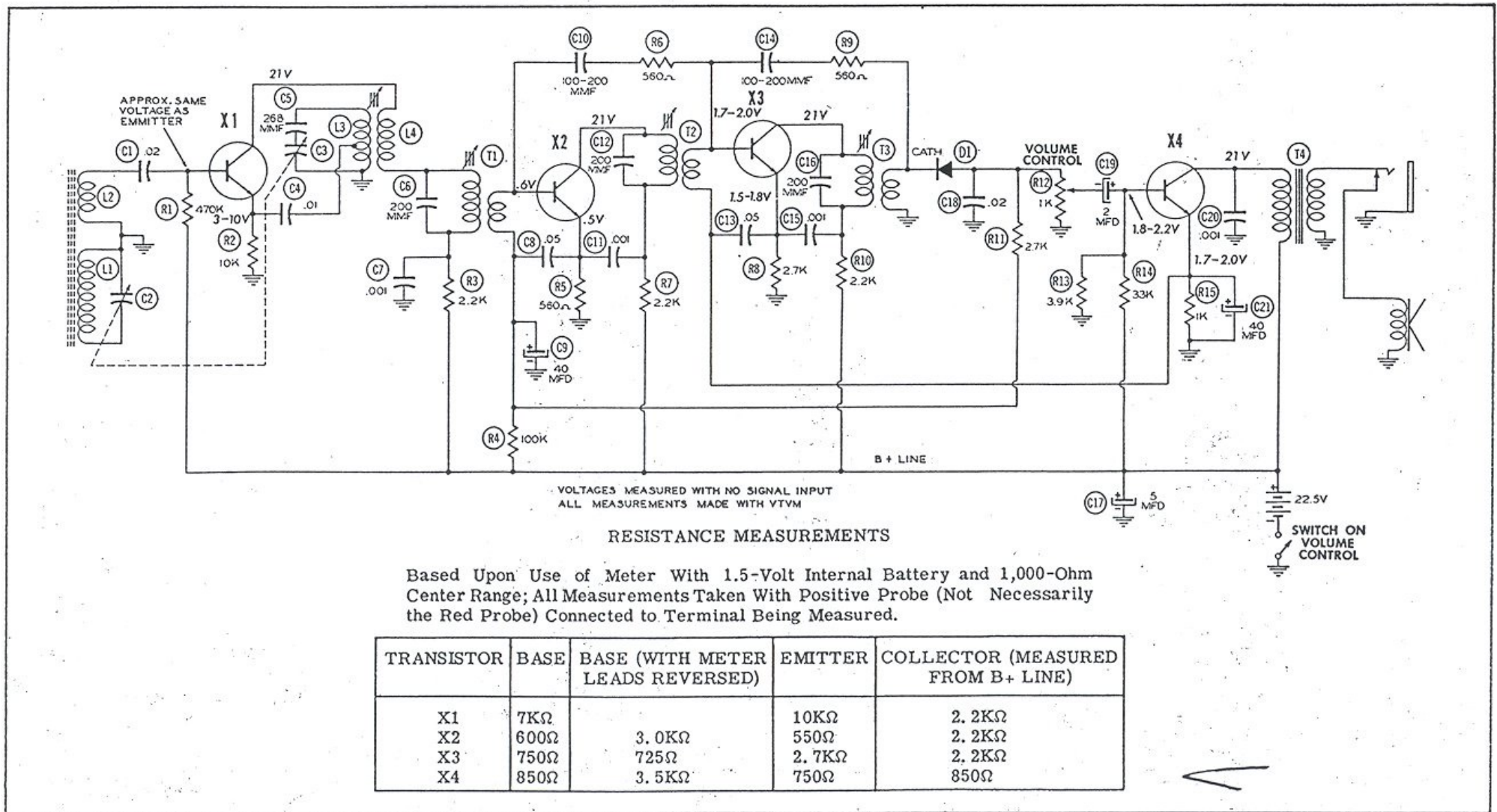

# 1954 – Erster Silizium Transistor

---

- Präsentation auf einer Konferenz:

'Teal, who came to TI in December 1952, was a speaker before the National Conference on Airborne Electronics to be held May 10, 1954, in Dayton, Ohio. The topic of his talk? "Some New and Recent Developments in Silicon and Germanium," an inauspicious title. The germanium transistor was no longer news.

Industry-wide research had been conducted for some time on the use of silicon for transistors, because of its ability to withstand higher temperatures. However, as far as anyone knew, no one had been able to grow silicon crystals with the characteristics needed for a workable transistor.

Speaker after speaker at the conference denied the near-term feasibility of the silicon transistor. Teal, next to last on the agenda, took his turn. TI cofounder Erik Jonsson recalled that **Teal, "a quiet man," put everyone to sleep until, at the end of his speech, he calmly remarked, "Contrary to what my colleagues have told you about the prospects for silicon transistors, I happen to have a few here in my pocket".**

Teal's announcement that someone from TI was standing in the back of the auditorium with literature on the new device caused a stampede. "The poor last speaker was in trouble," Jonsson remembered. "He had no audience left."

- Vorteil von Silizium (zunächst):
  - Höhere Betriebstemperatur (bis 150°C)
  - höhere Ausgangsleistung



# 1958 – Die erste 'integrierte Schaltung'

- Erste integrierte Schaltung – Jack Kilby, **Texas Instruments**
- 1 Transistor, 1 Kondensator, 3 Widerstände auf einem Chip, Germanium
- Nobelpreis 2000
- <http://www.ti.com/corp/docs/company/history/tihistory.htm>

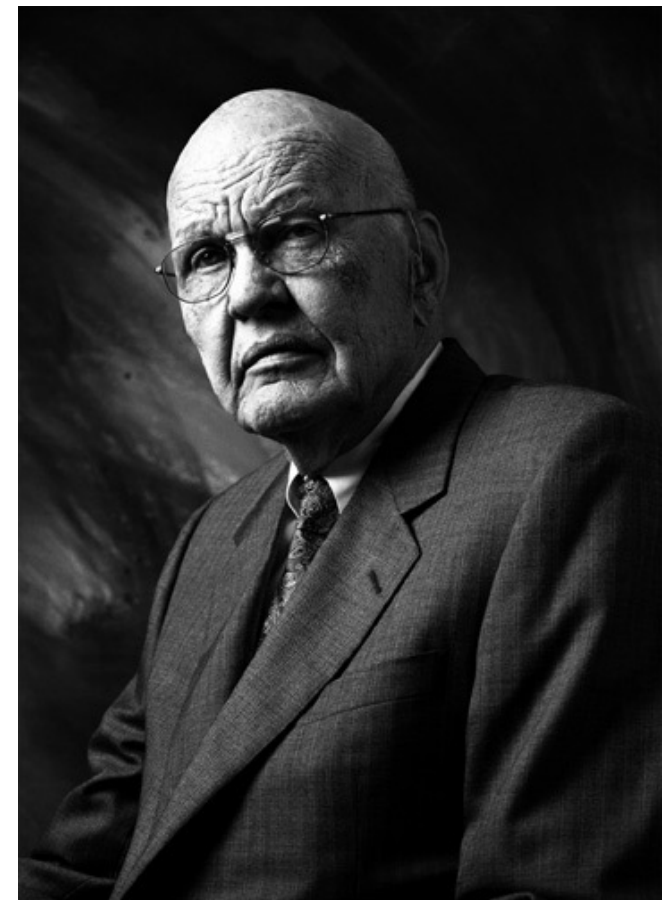
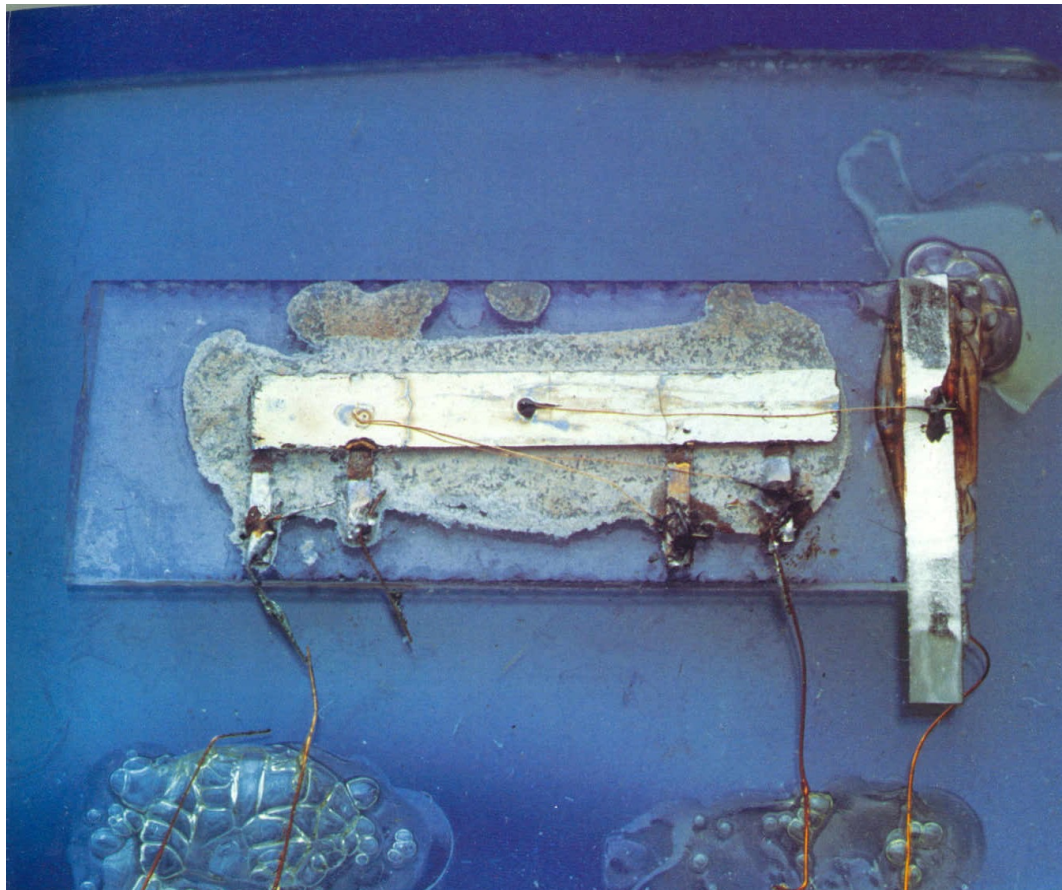



# Mesa Technology oder Planarprozess ?

- Es wurden einfache & gute Verfahren zur Massenfabrikation von Transistoren gesucht
- Beim 'Mesa'-Prozess werden Lagen sukzessive aufgebracht. Die Methode setzt sich nicht durch.
- → **pnp-Transistor aus Silizium**

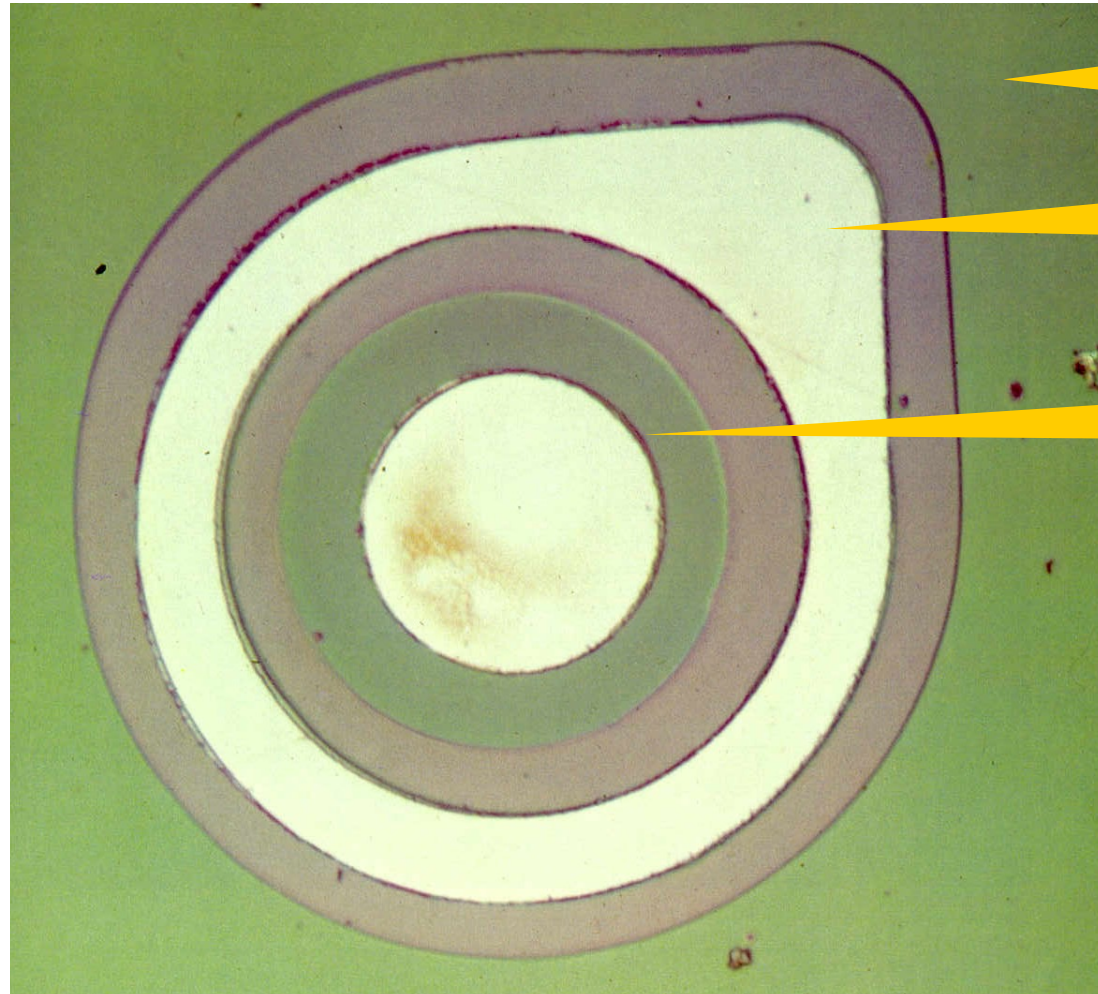

Kollektor  
(Substrat)

Basis  
mit Al-Kontakt

Emitter  
mit Al-Kontakt

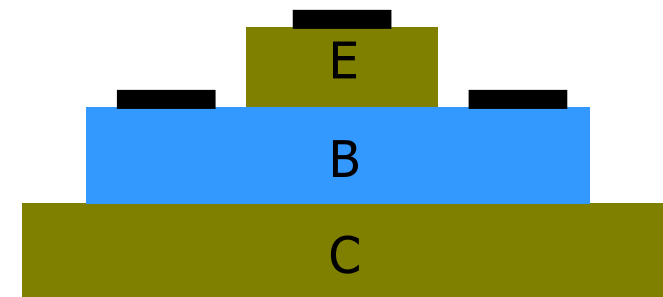

# 1961 – Erster kommerzieller planarer IC

- **Fairchild Electronics** - Jean Hoerni und Robert Noyce: Planartechnologie
- **Fairchild - Ein Bit** Digitaler Speicher (Flipflop) in Resistor-Transistor-Logic (RTL)
- 4 Transistoren, 5 Widerstände – Integration von weiteren Elementen in Planartechnologie einfach!
- Beginn der 'Small Scale Integration' SSI – selbst TI übernahm nun die Planartechnologie.

- Die Planartechnologie setzt sich durch:  
Das Si-Substrat wird durch Eindiffundieren von Fremdatomen (Dotieren) verändert, um Basis und Emitter anzulegen.

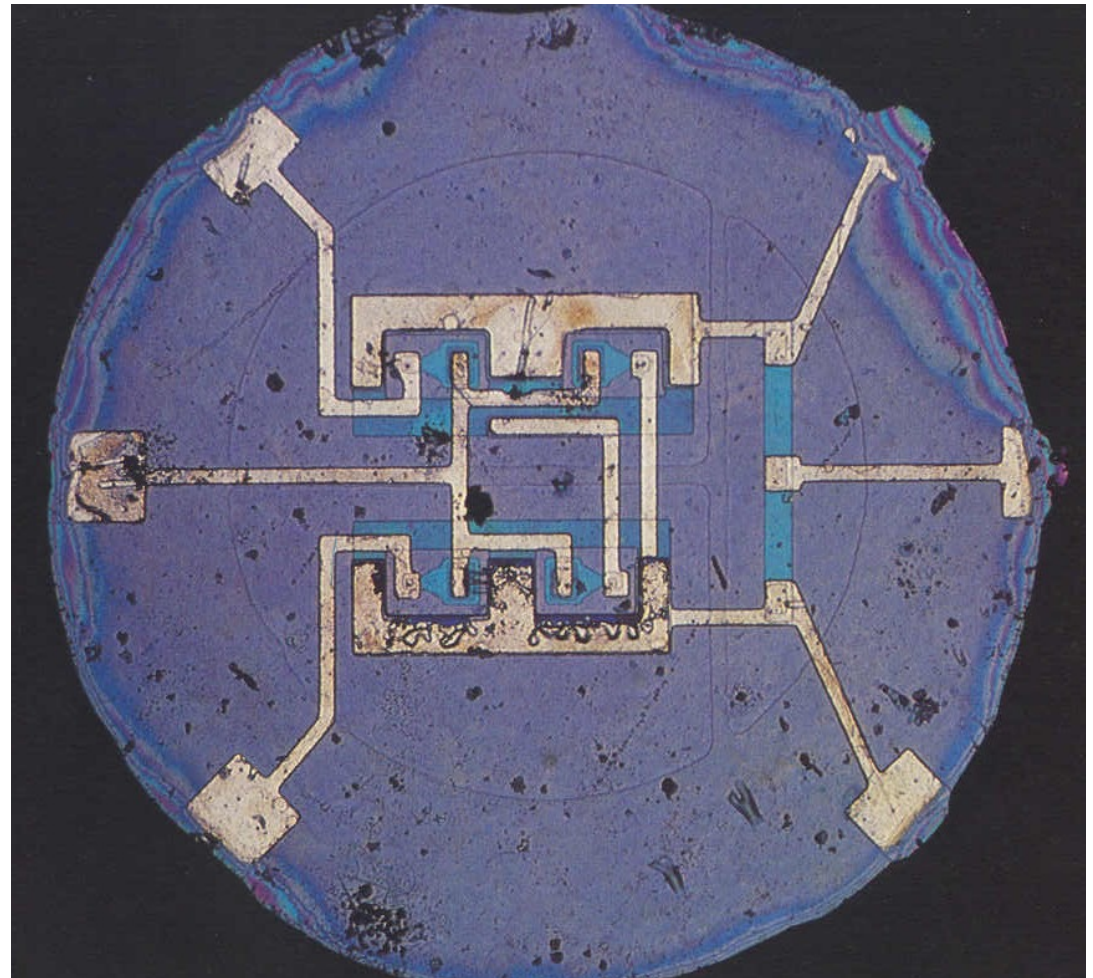
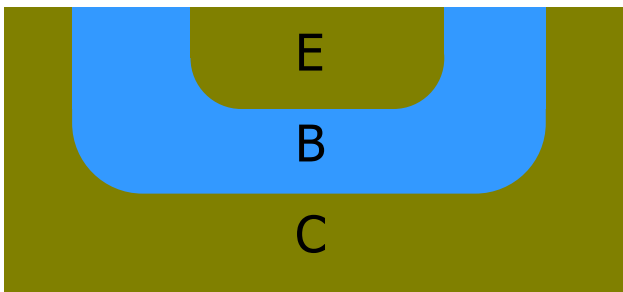



# 1962 – Der erste MOSFET

- Metal-Oxide Semiconductor Field-Effect Transistor
- Radio Corporation of America (**RCA**)
- 'General Purpose Chip' mit 16 Transistoren:

Film: [fieldeffect.mov](#)

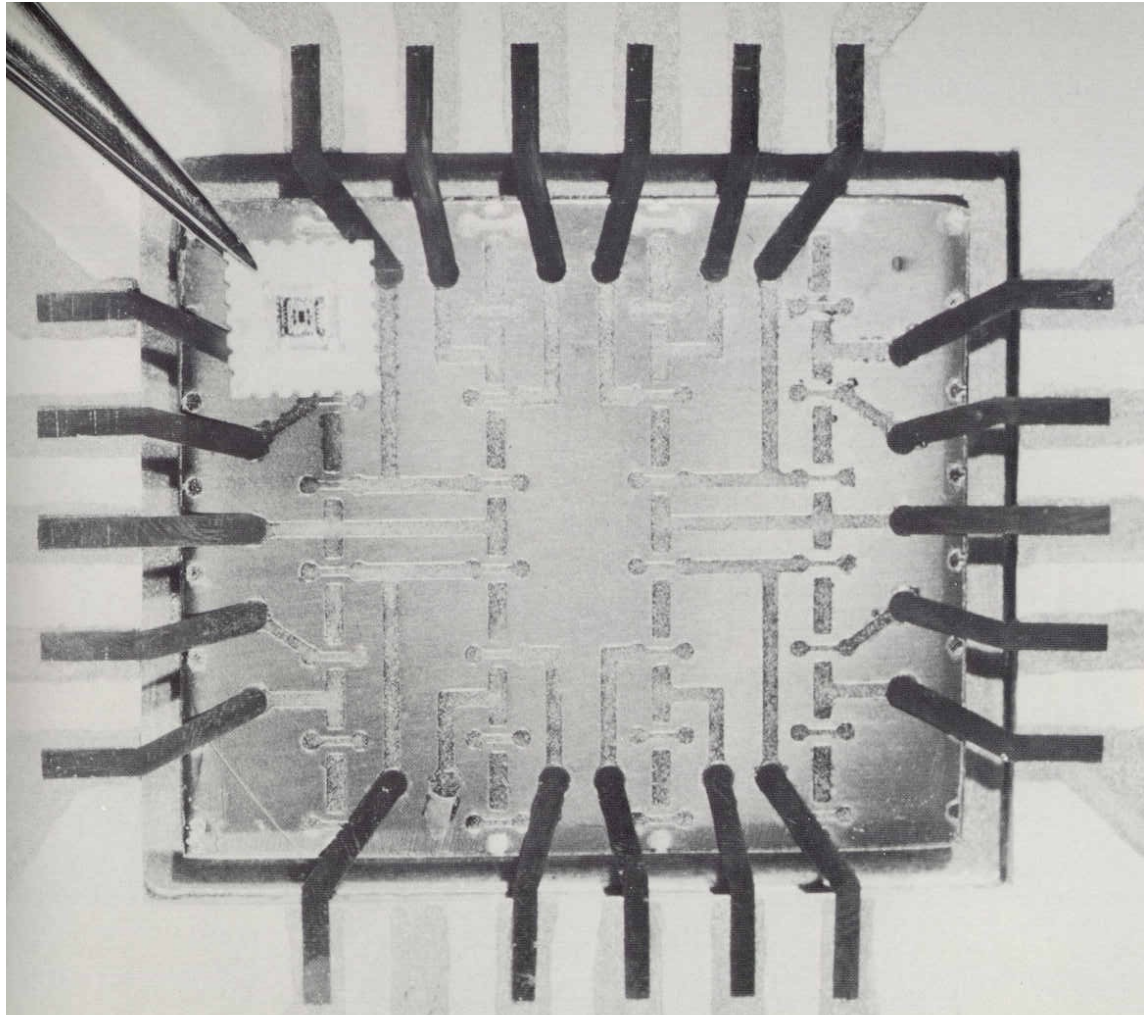

# 1963 – RTL Logic

- **Fairchild '907'**: RTL Logik: 4 Transistoren, 5 Widerstände
- 'Burried Layer' unter dem Kollektor reduziert Widerstand  $\Rightarrow$  höhere Geschwindigkeit

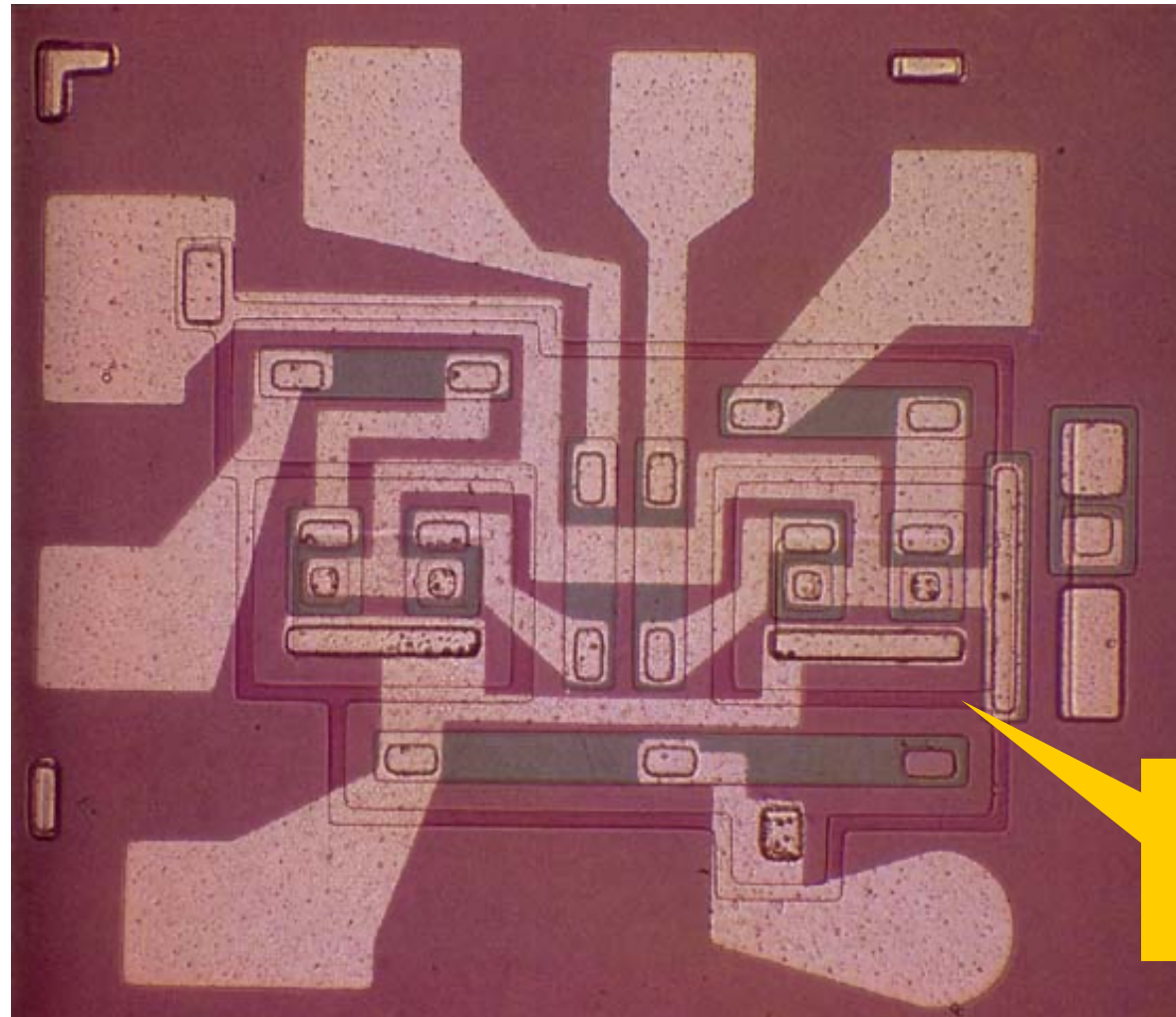

Isolation von  
Transistor-  
Gruppen



# 1946 – ENIAC, der erste elektronische Computer

- **E**lectronic **N**umerical **I**ntegrator **A**nd **C**omputer
- 19.000 Röhren, 175 kW Leistung, 30 Tonnen Gewicht
- Durchschnittliche Zeit zwischen 2 Wartungen: 5.6 Stunden
- Pro Sekunde: 5000 Additionen, 360 Multiplikationen oder 38 Divisionen

<http://ftp.arl.mil/~mike/comphist>

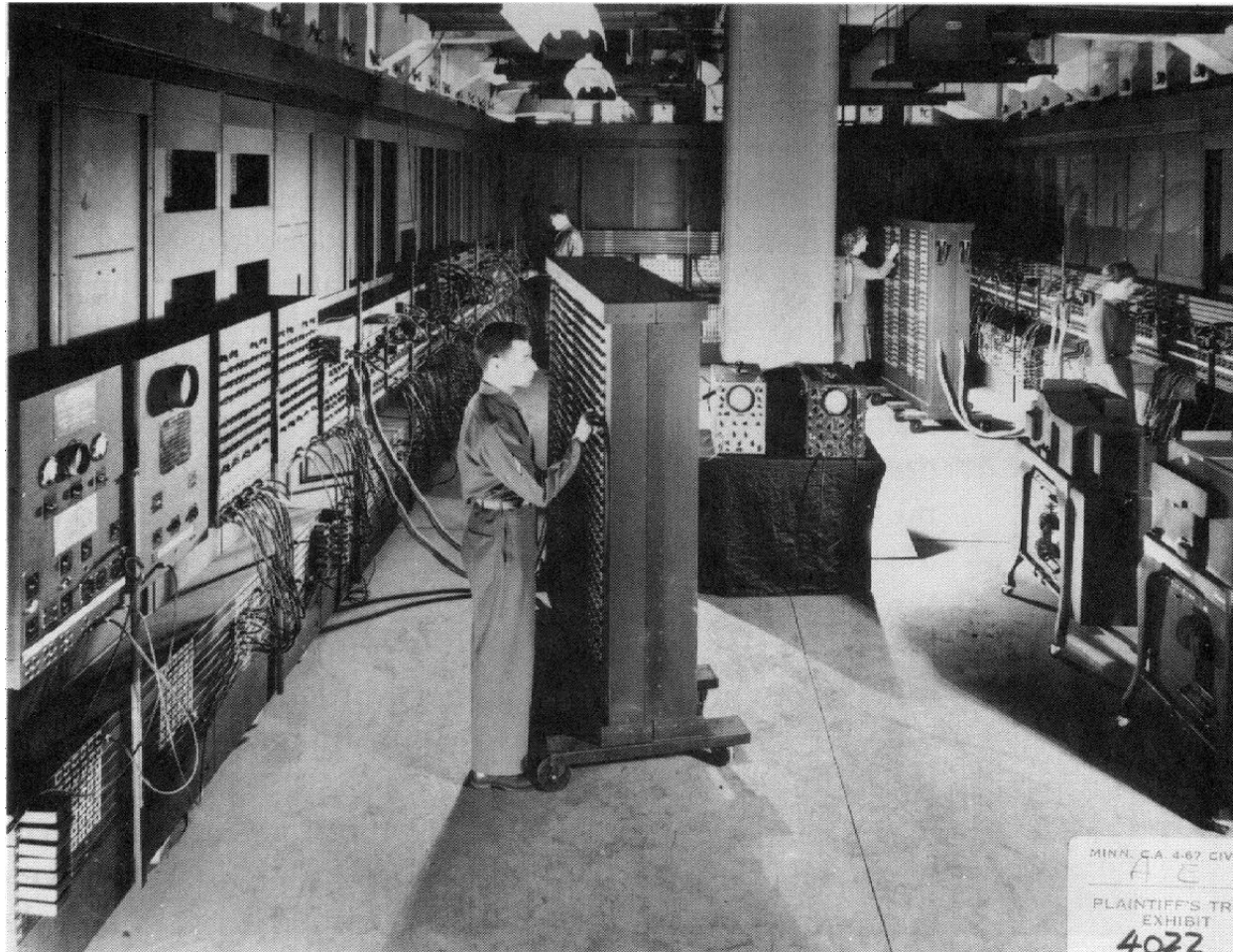

Rechner von Konrad Zuse:  
1938: Z1, mechanisch, 1Hz  
1939: Z2, 200 Relais, 3Hz  
1941: Z3, 2000 Relais, 5Hz



# ENIAC: Vakuum-Röhren

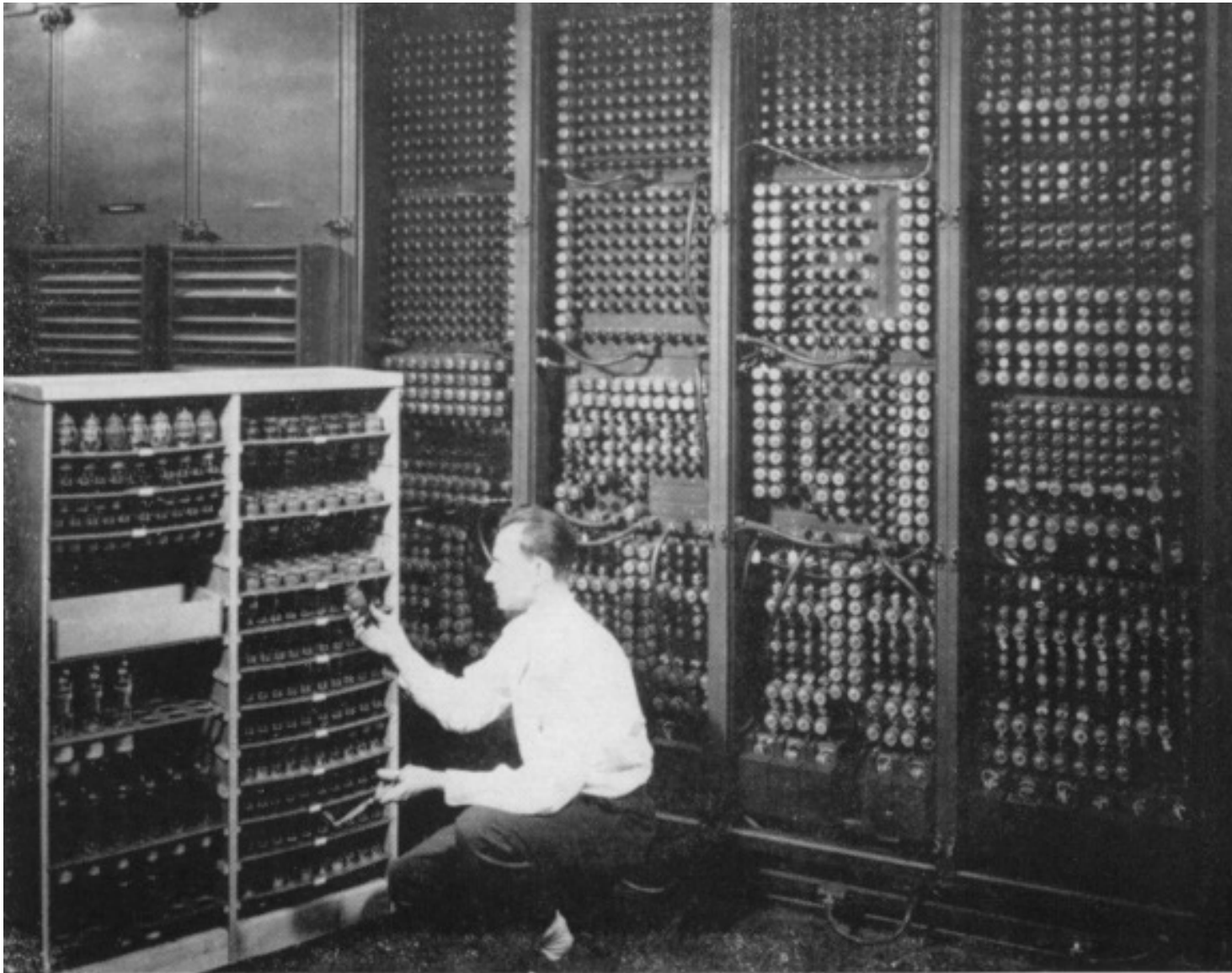

Replacing a bad tube meant checking among ENIAC's 19,000 possibilities.

## *Nobel Physics Prize Goes to 3 Americans; 2 Chemists Honored*

By FELIX BELAIR Jr.

Special to The New York Times.

STOCKHOLM, Sweden, Nov. 1

—The 1956 Nobel Prize in Physics was awarded today to three Americans who had worked as a team in developing the transistor. This is a tiny and highly efficient substitute for the vacuum tube in electronics.

The prize winners are Dr. William Shockley, the team captain; Dr. Walter H. Brattain and Dr. John Bardeen. The three, who did their work as research scientists of the Bell Laboratories of Murray Hill, N. J., will share the award of about \$38,700 made under the terms of the will of Alfred Nobel, the Swedish inventor of dynamite.

# ENIAC 'Board' & spätere Generationen

---





# 1964 – Erster analoger IC

- **Fairchild:** Operationsverstärker  $\mu$ A 702
- Der erste integrierte Differenzverstärker

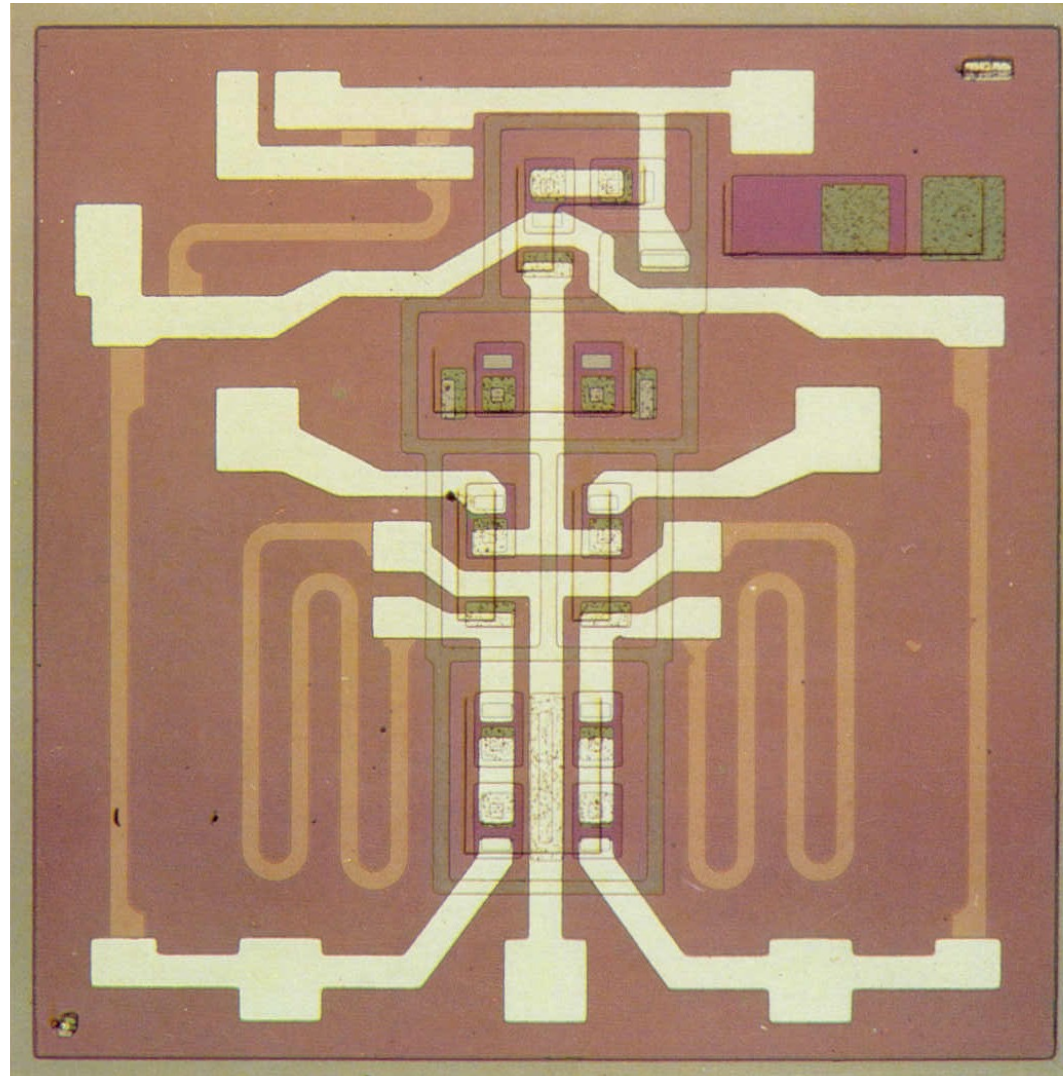

1.5 cm (!)

# 1965 – Ein 'Bestseller'

- **Fairchild: OV  $\mu$ A 709** - Entworfen vom 'legendären' **Robert ('Bob') Widlar**
- 14 Transistoren, 15 Widerstände
- Wird immer noch hergestellt!
- Verstärkung  $\sim 70000$
- Preis 1968: \$100
- Heute: \$0.5
  
- Konkurrenz erst 1968 vom  $\mu$ A 741 (Texas Instruments)

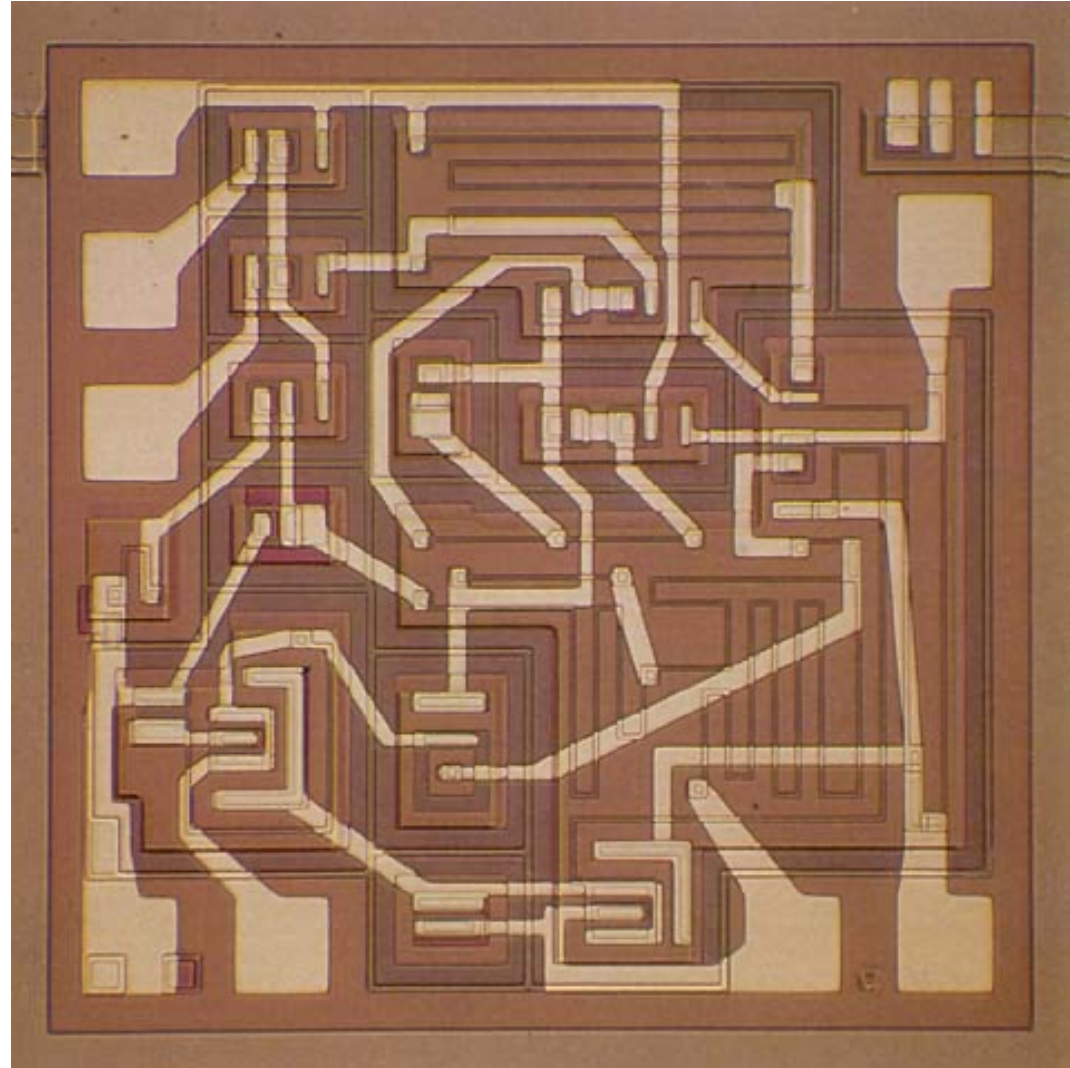

# 1966 – ECL

- **Motorola**
- Gate mit 3 Eingängen
- Bipolare Transistoren und Widerstände
- Wie alle bisher nur 1 Metallage

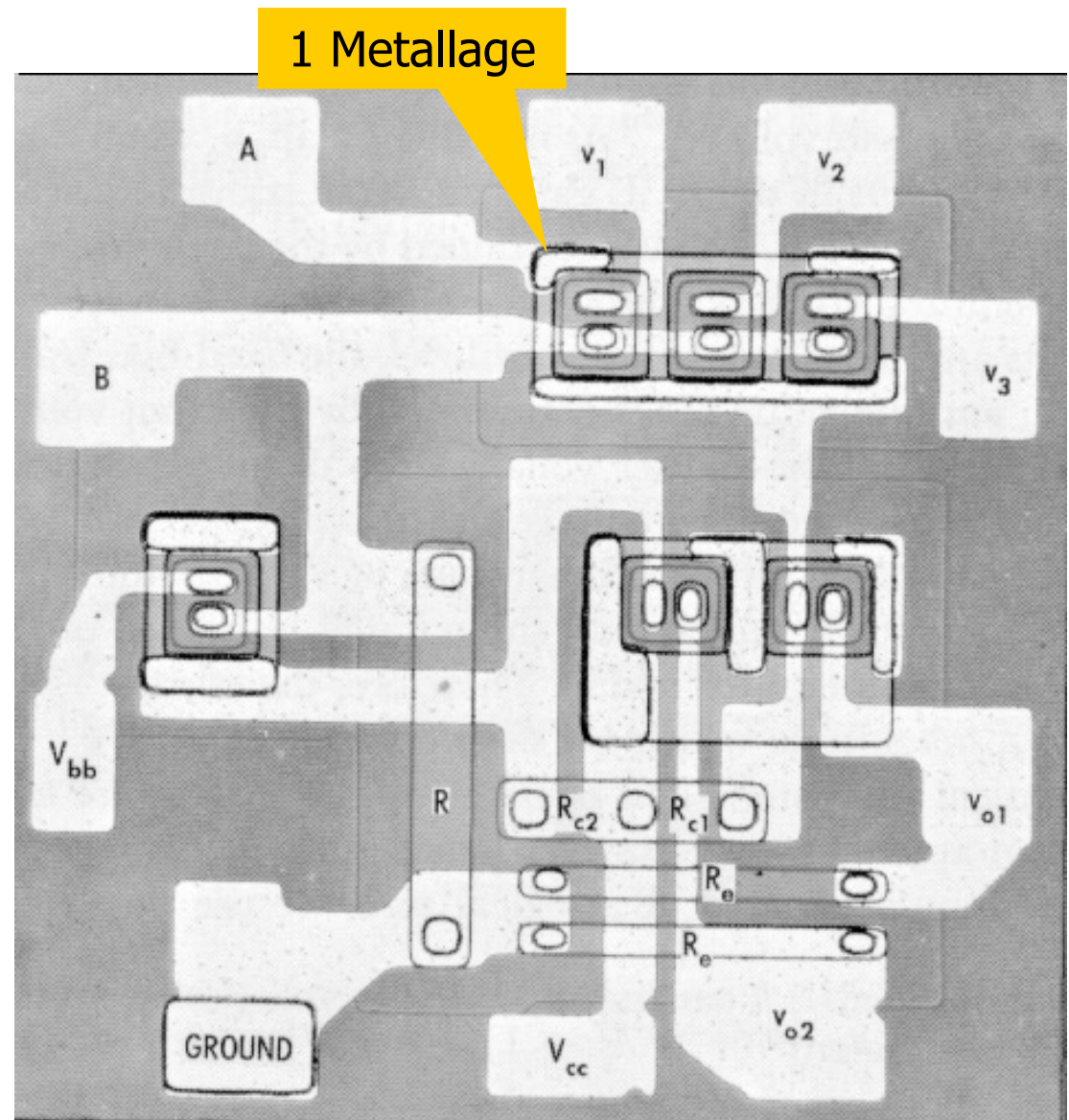

- TI eröffnet Produktion in Freising



# 1967 – Erster IC, der mit CAD generiert wurde

- **Fairchild:** MICROMOSAIC
- ca. 150 AND, OR, NOT Gatter
- Generiert aus einem Pool von Transistoren durch 'anwendungsspezifische' Verdrahtung
- 'Mask programmable transistor array'

4 mm

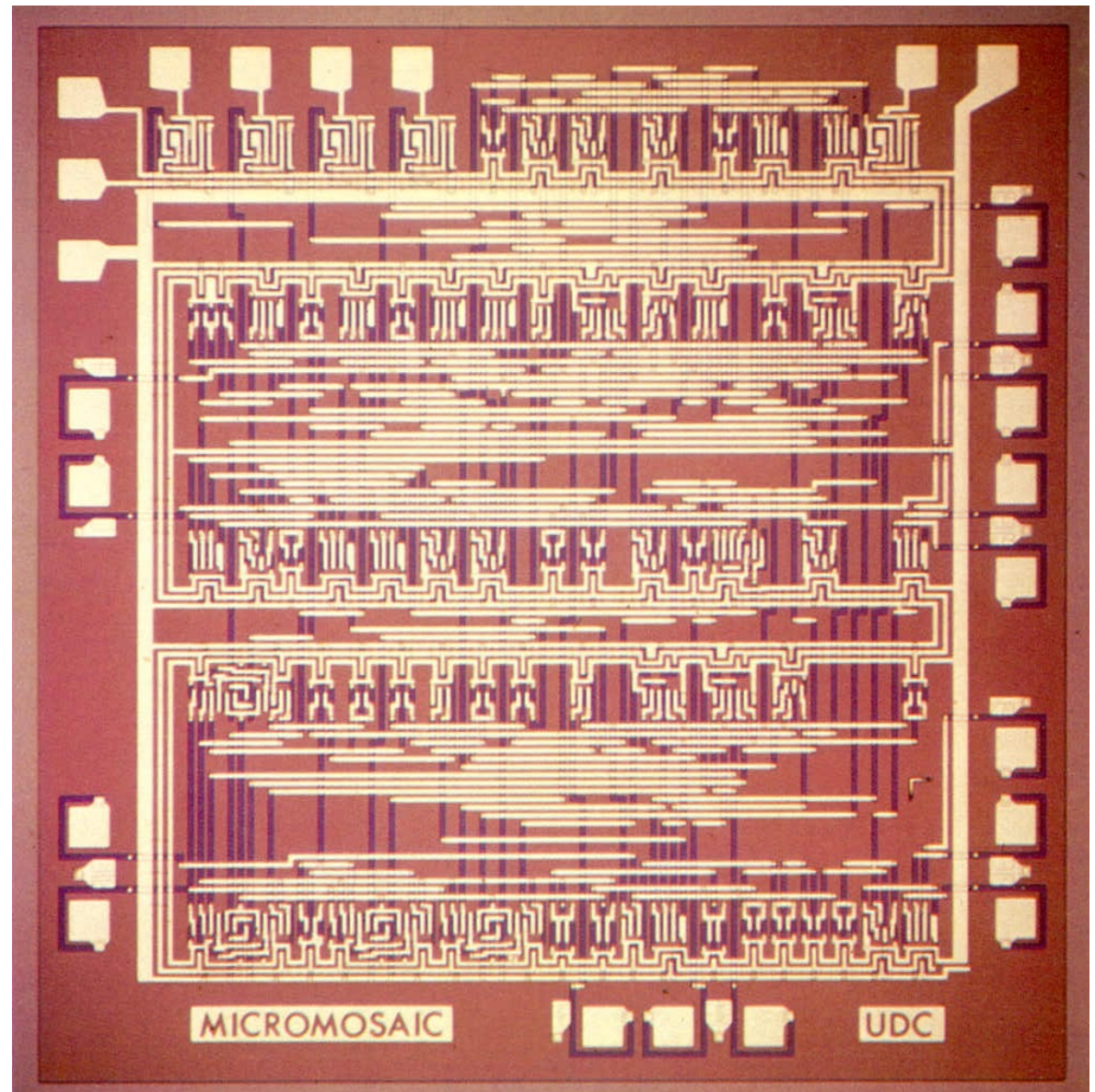

# 1969

---

- 20. Juli 1969: erste Mondlandung (Apollo 11) – mit der zu diesem Zeitpunkt verfügbaren Technik...





# Der 'Apollo Guidance Computer' AGC

- 15Bit + 1 Parity Bit
- Clock  $\sim$  1MHz
- Cycle Zeit 11.7  $\mu$ s  $\rightarrow$  43K ops/s
- 2k words RAM
- 36k words ROM
- Gewicht  $\approx$  32kg
  
- ‚Top‘ Rechner der Zeit ca. 10x schneller (und größer, schwerer..)

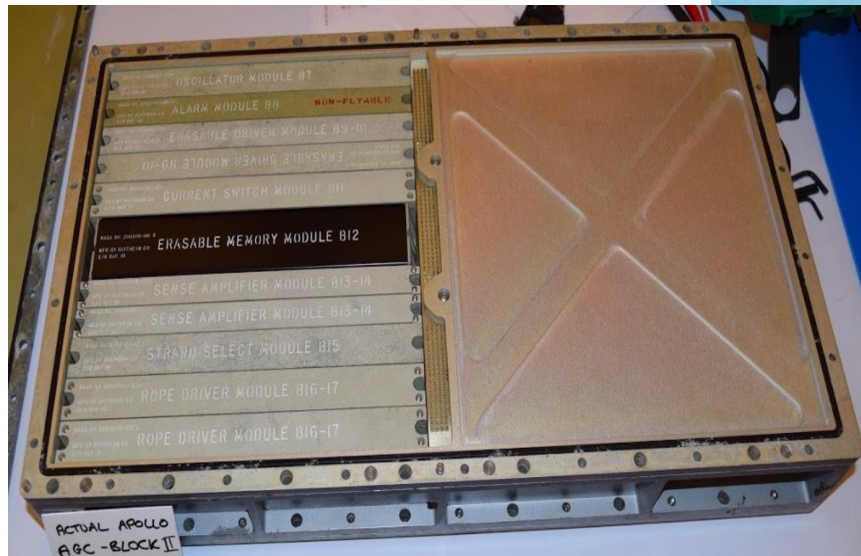
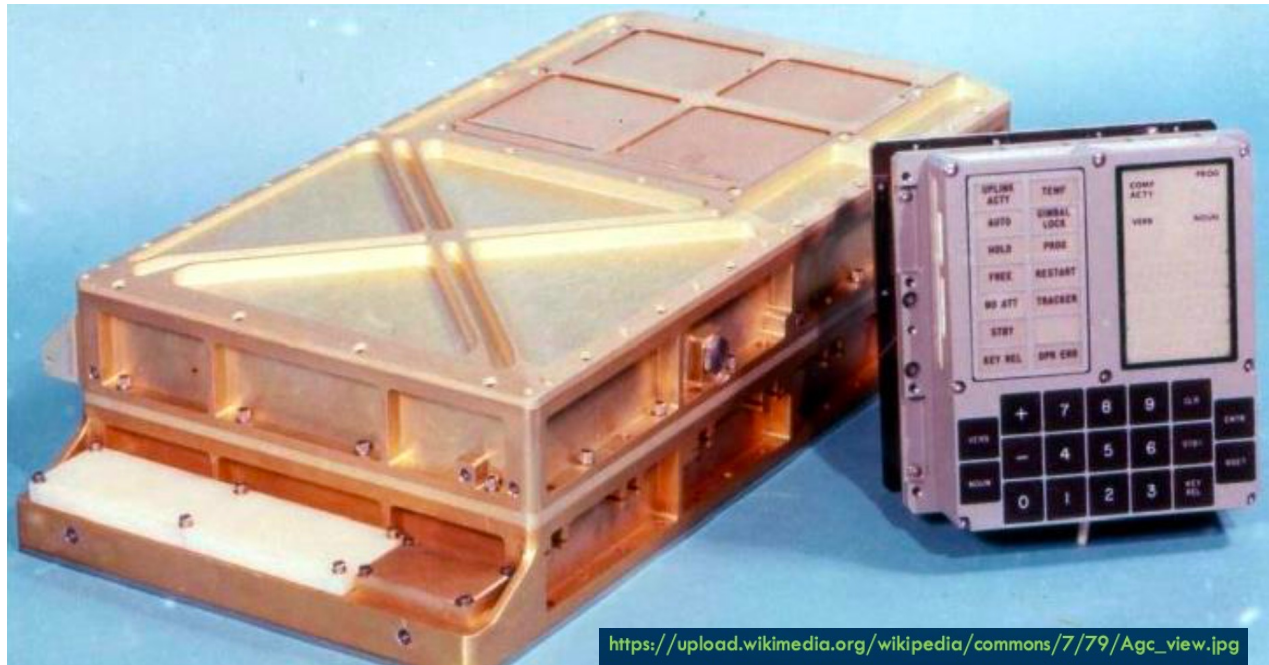



# Speicher: Ringkerne!

- 1/0 gespeichert durch Magnetisierung Kleiner Ferrit-Ringe. Standard zu der Zeit
- Schreiben und Lesen über mehrere Drähte
- 'Festspeicher' Funktion über Verkabelung der Drähte

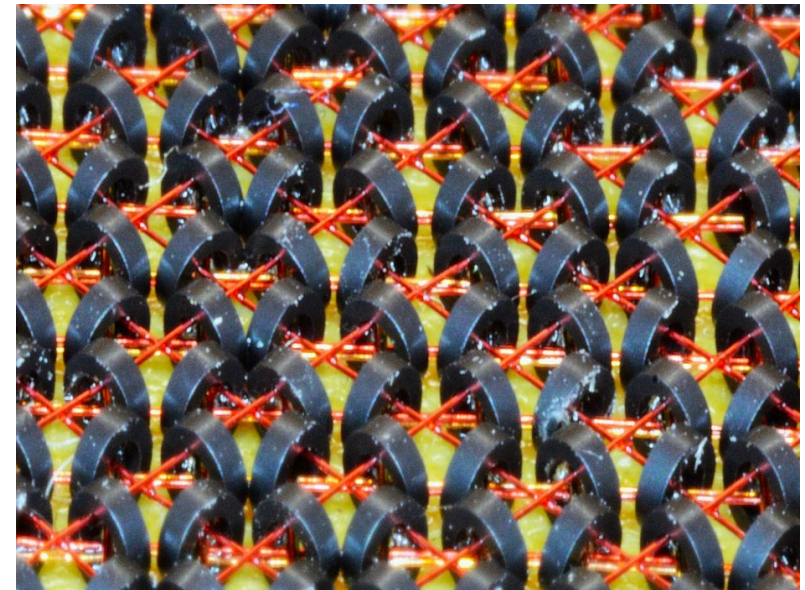
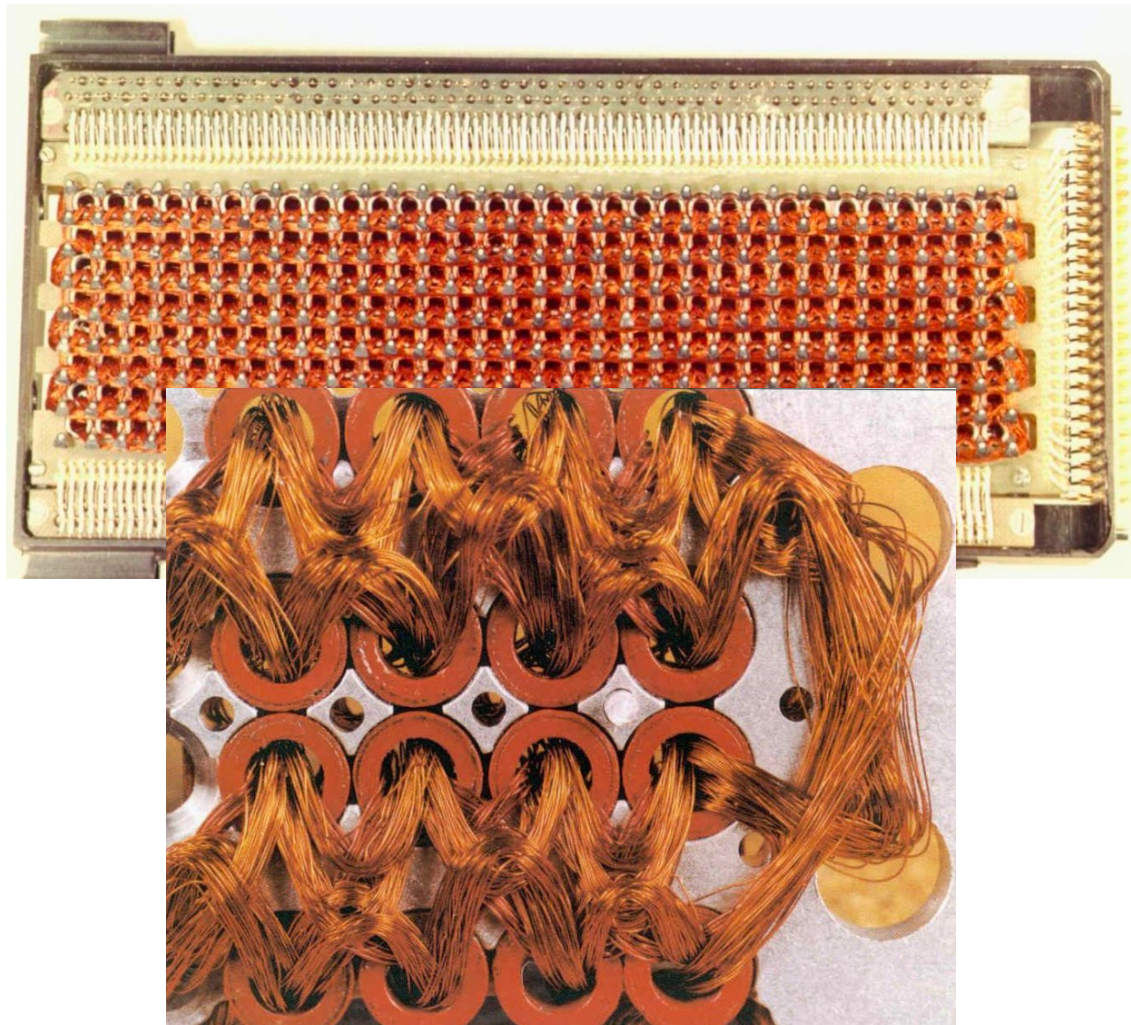

[http://static.righto.com/images/agc-rope/Plate\\_19.jpg](http://static.righto.com/images/agc-rope/Plate_19.jpg)



# Grundelement der Logik

- Chips mit 2 NOR Gates mit je 3 Eingängen
- 6 Transistoren und 8 Widerstände (Resistor-Transistor-Logic, RTL)
- 5600 solche ICs in einem AGC

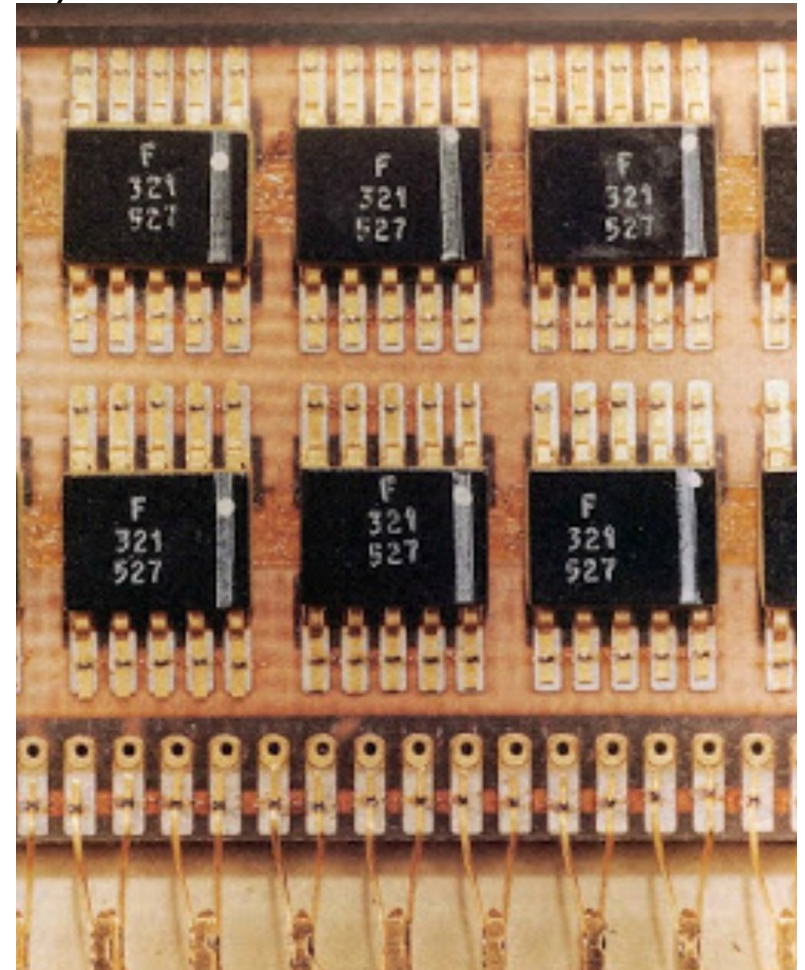
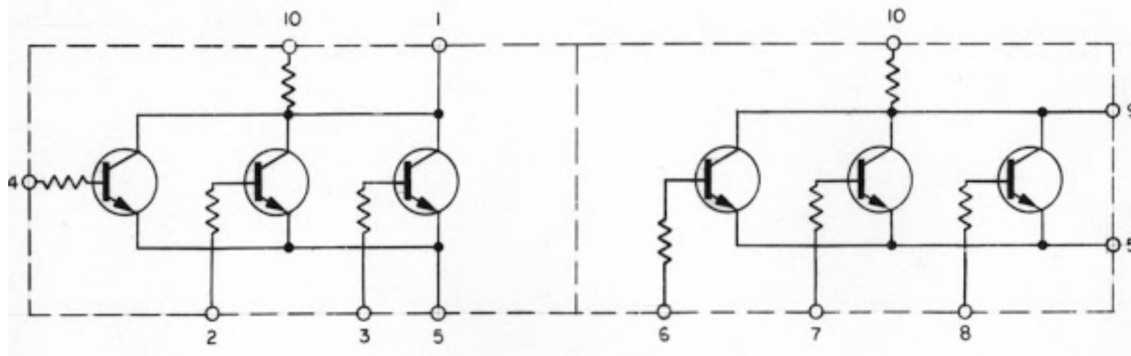
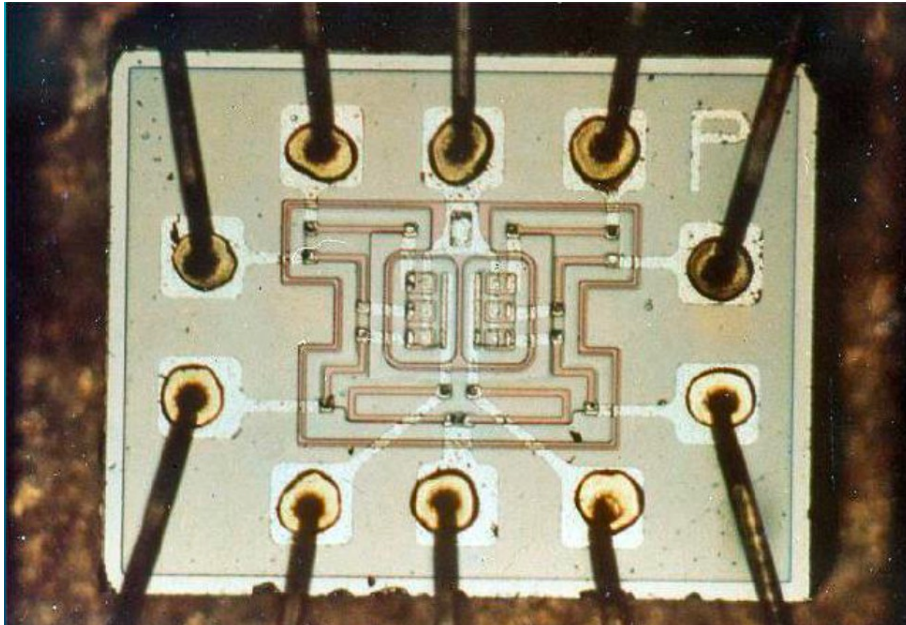

<https://djjondent.blogspot.com/2019/07/the-apollo-guidance-computer-nor-gate.html>



# Schaltpläne

- Verfügbar im Netz, z.B. [http://klabs.org/history/ech/agc\\_schematics/](http://klabs.org/history/ech/agc_schematics/)
- Nur NOR Gatter...

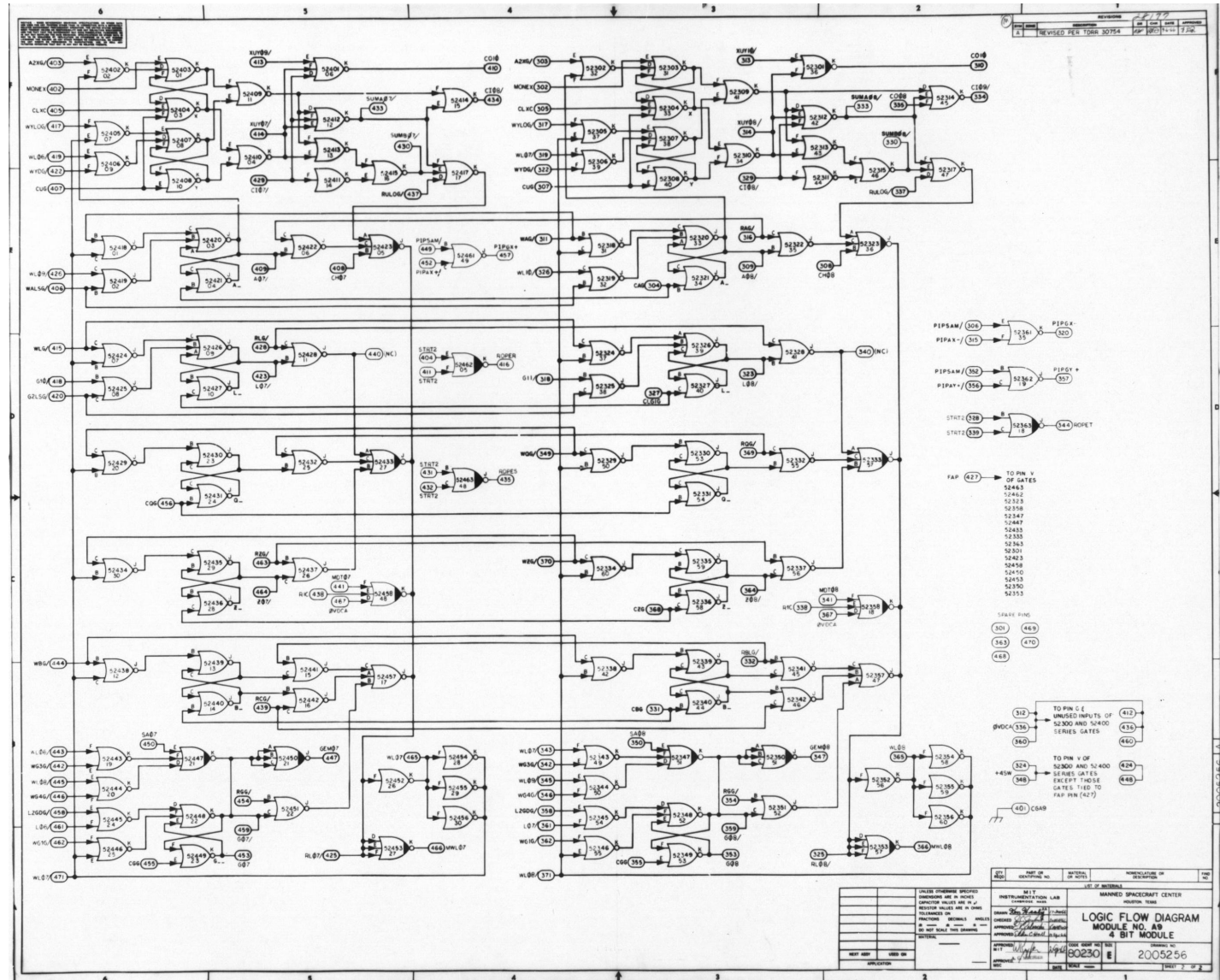



# 1970 – 256 Bit statisches RAM

- **Fairchild** 4100
- Mit Decoder
- 0.25 cm x 0.3 cm
- Eingebaut in den ILLIAC IV Computer (NASA)

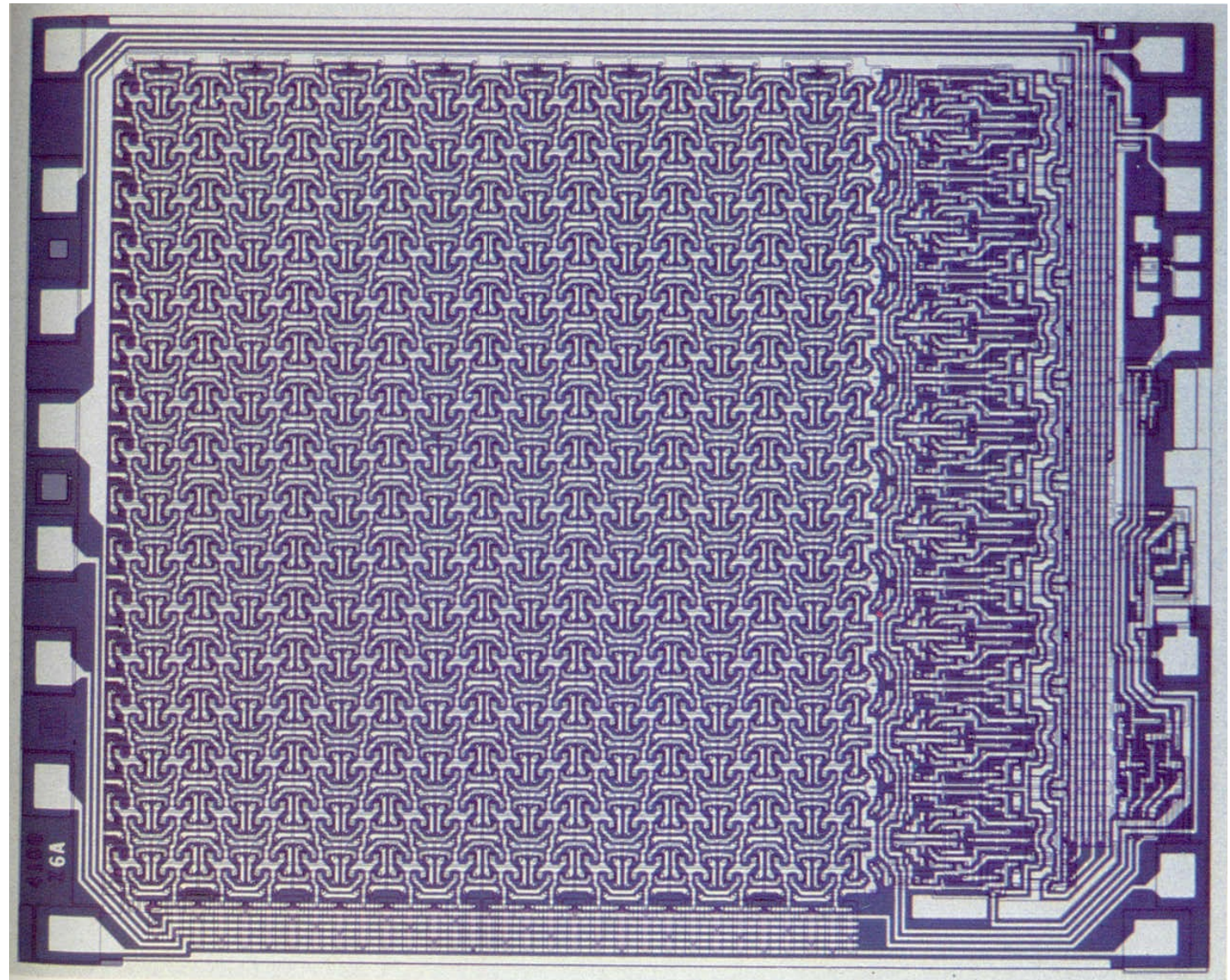



# 1970 – 1024 Bit dynamisches RAM

- **Intel Corporation** (**I**ntegrated **E**lectronics)
- Gegründet 1968 von Mitarbeitern von Fairchild (Bob Noyce, Gordon Moore)
- 4 x mehr Bits auf gleicher Fläche wie statische RAMs

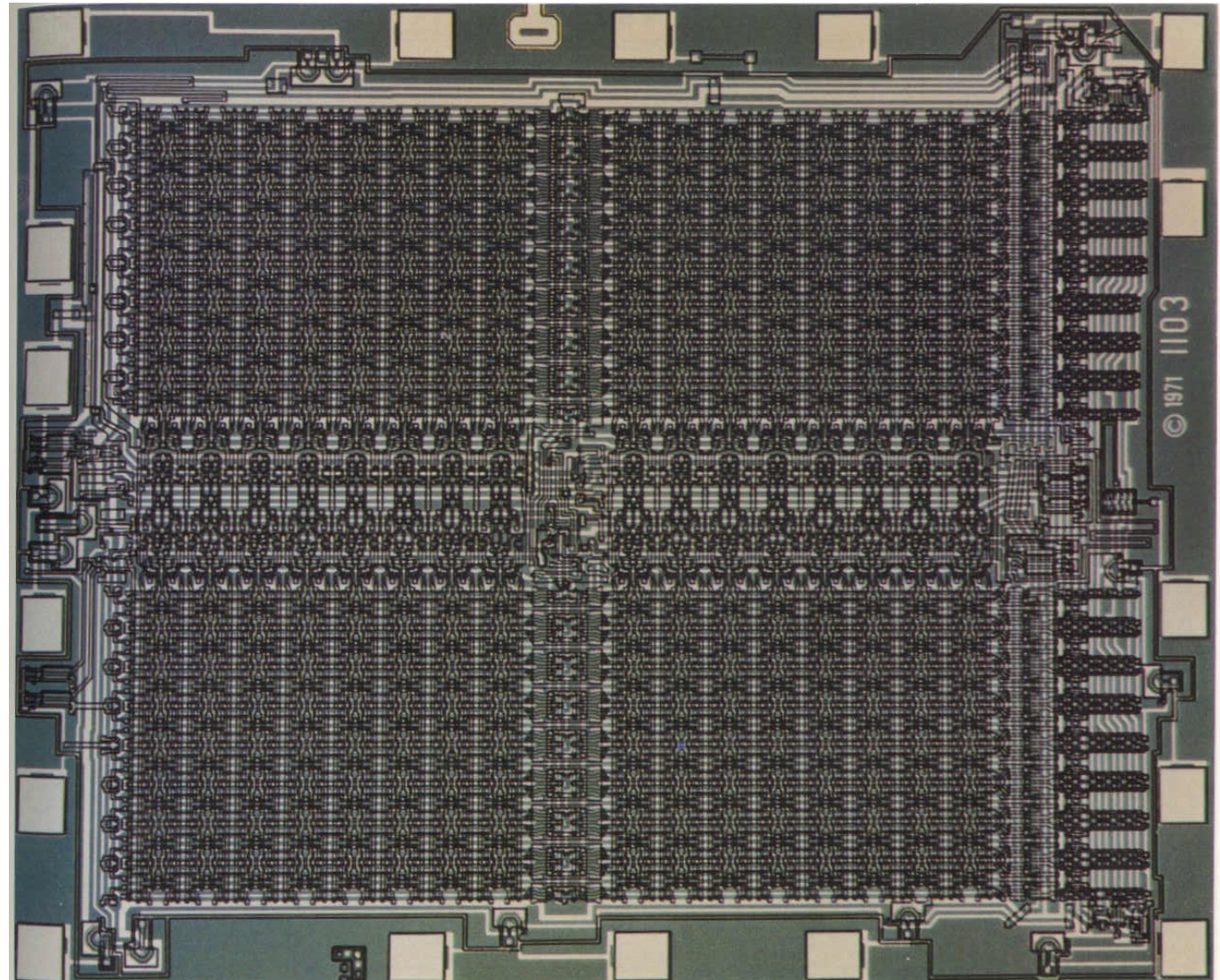



# 1971 – Der erste Mikroprozessor 4004

- **Intel** 4004 (Marcian E. Hoff)
- Der erste 'Computer' auf einem Chip – Beginn der Large Scale Integration (LSI)
- 2300 MOS Transistoren
- 4bit
- 108 kHz Clock

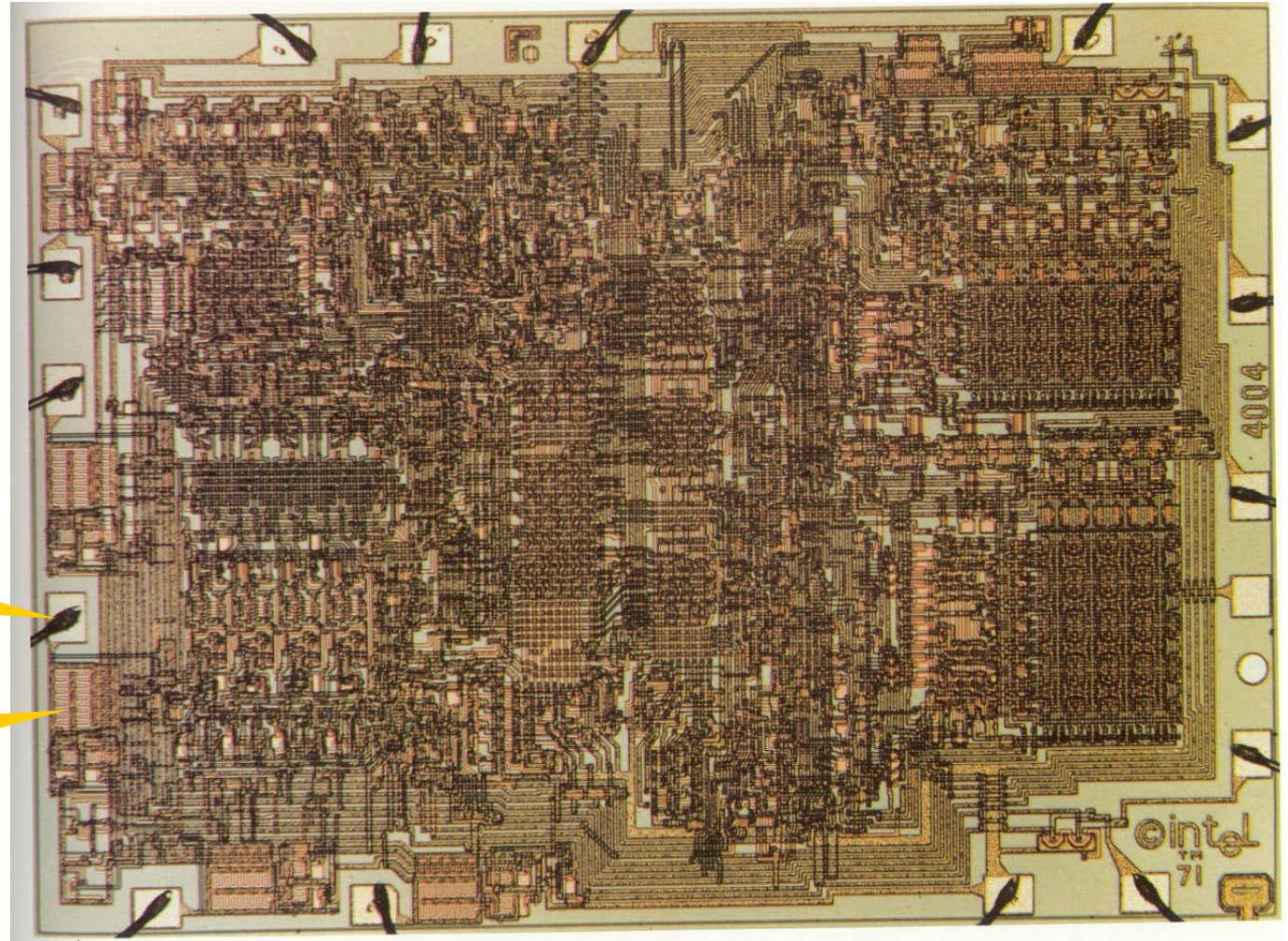

Aluminium-  
Wire-Bonds

'Richtige'  
Eingangs- Pads



# 1971 – das erste EPROM

- **Intel 1702**
- 2k Bit (256 x 8)
- UV-löschbar
- 3.7mm x 4.1 mm
  
- Damit konnten Intel's Kunden den Mikroprozessor selbst programmieren

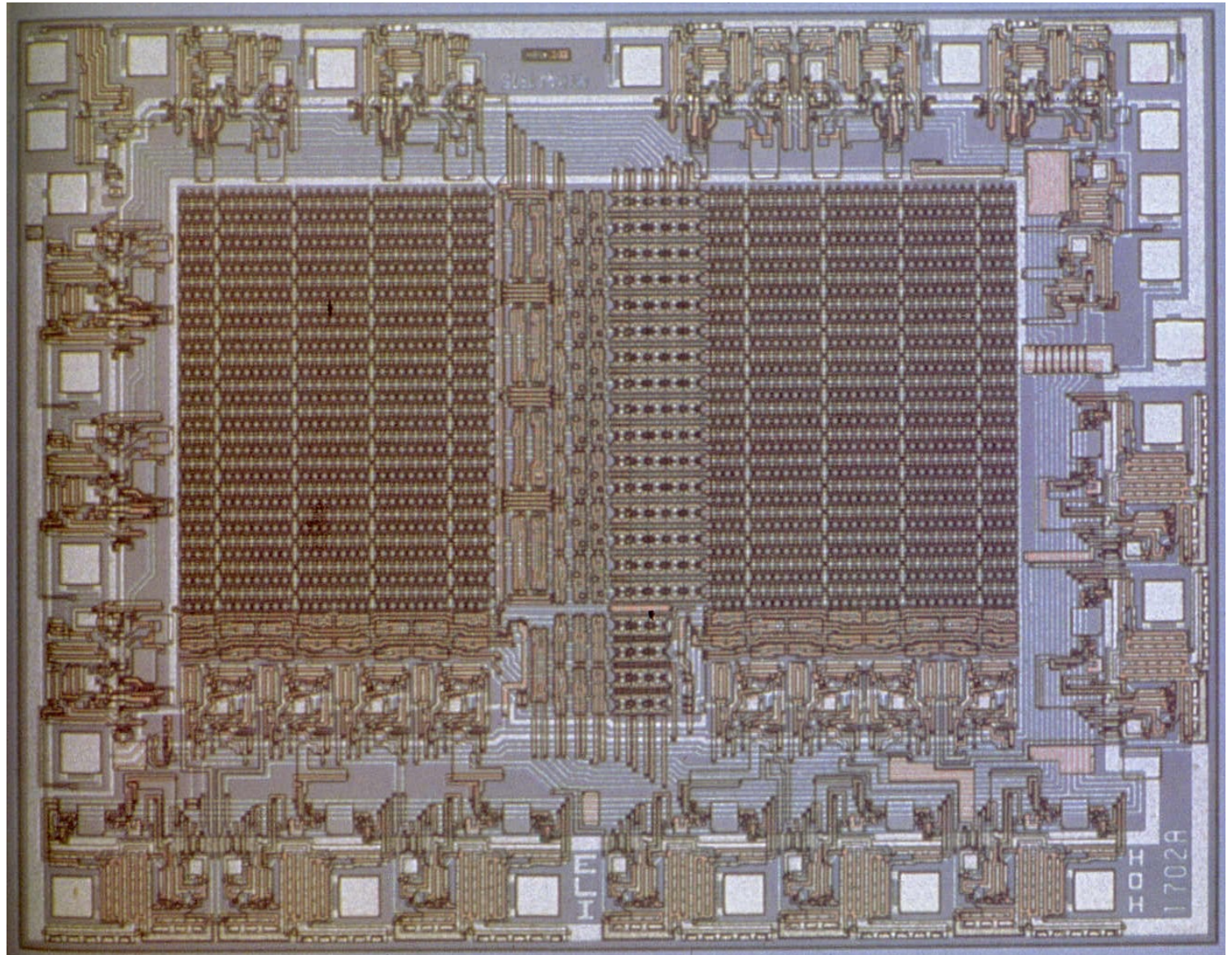



# 1974 – der 8080 Universal-Prozessor

- **Intel 8080**
- 5000 Transistoren
- 6  $\mu\text{m}$  Technologie
  
- 2 MHz clock
- 8 bit
- 4 mm x 5 mm
  
- Wird von über 12 Firmen in Lizenz immer noch hergestellt
  
- 1981 hat Intel 20000 Mitarbeiter und setzt \$780 Mio um (!)

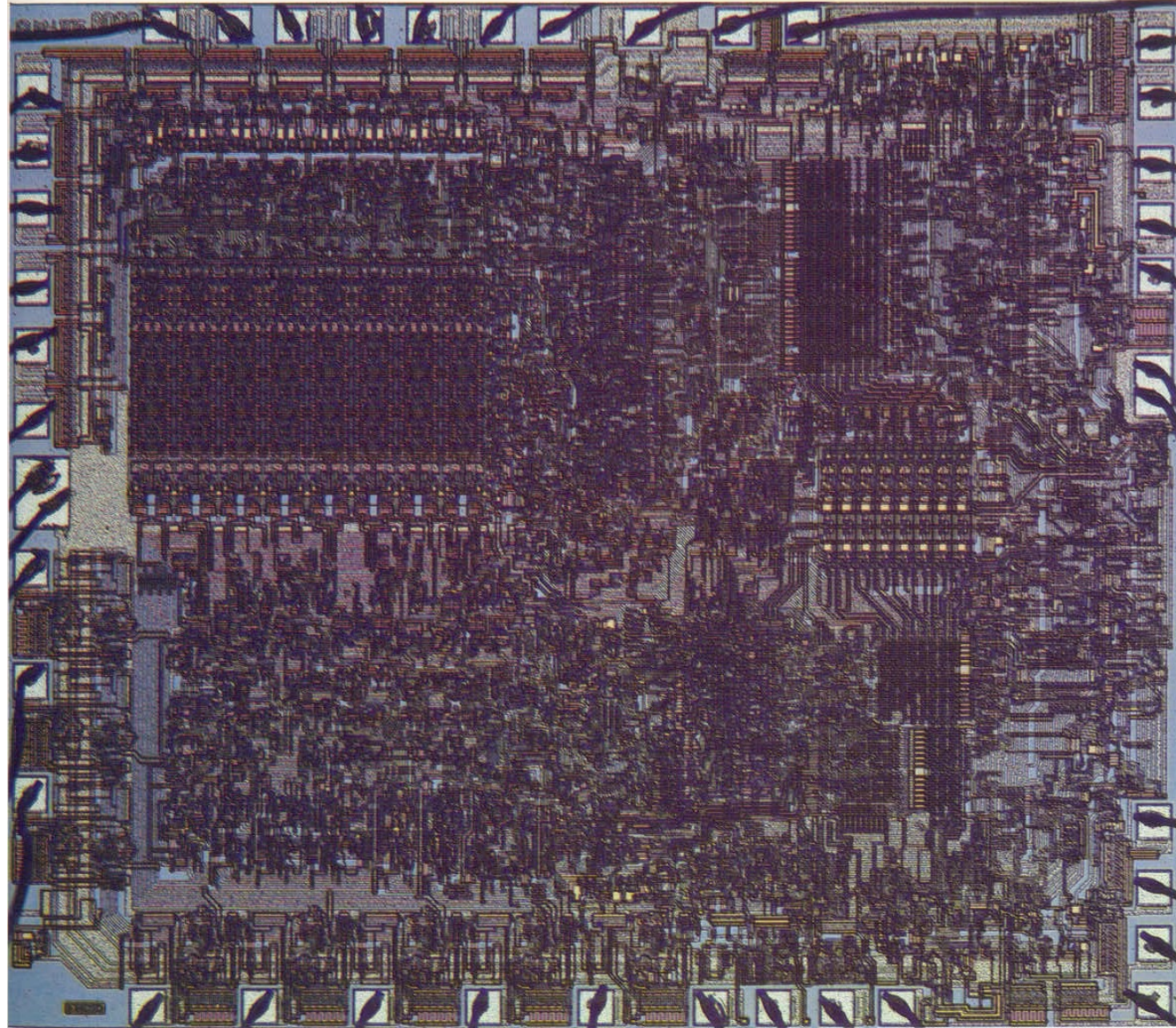



# 1974 – Konkurrenz von TI

- **Texas Instruments** TMS 1000
- 'MicroComputer'
- CPU (4 bit)  
+ 256 bit RAM (rechts)  
+ 1 kbit ROM (links)  
auf einem Chip
- Bereits 2 Jahre vorher in den  
Taschenrechnern von TI  
eingesetzt
- Sehr weit verbreitet in  
Consumer Electronics

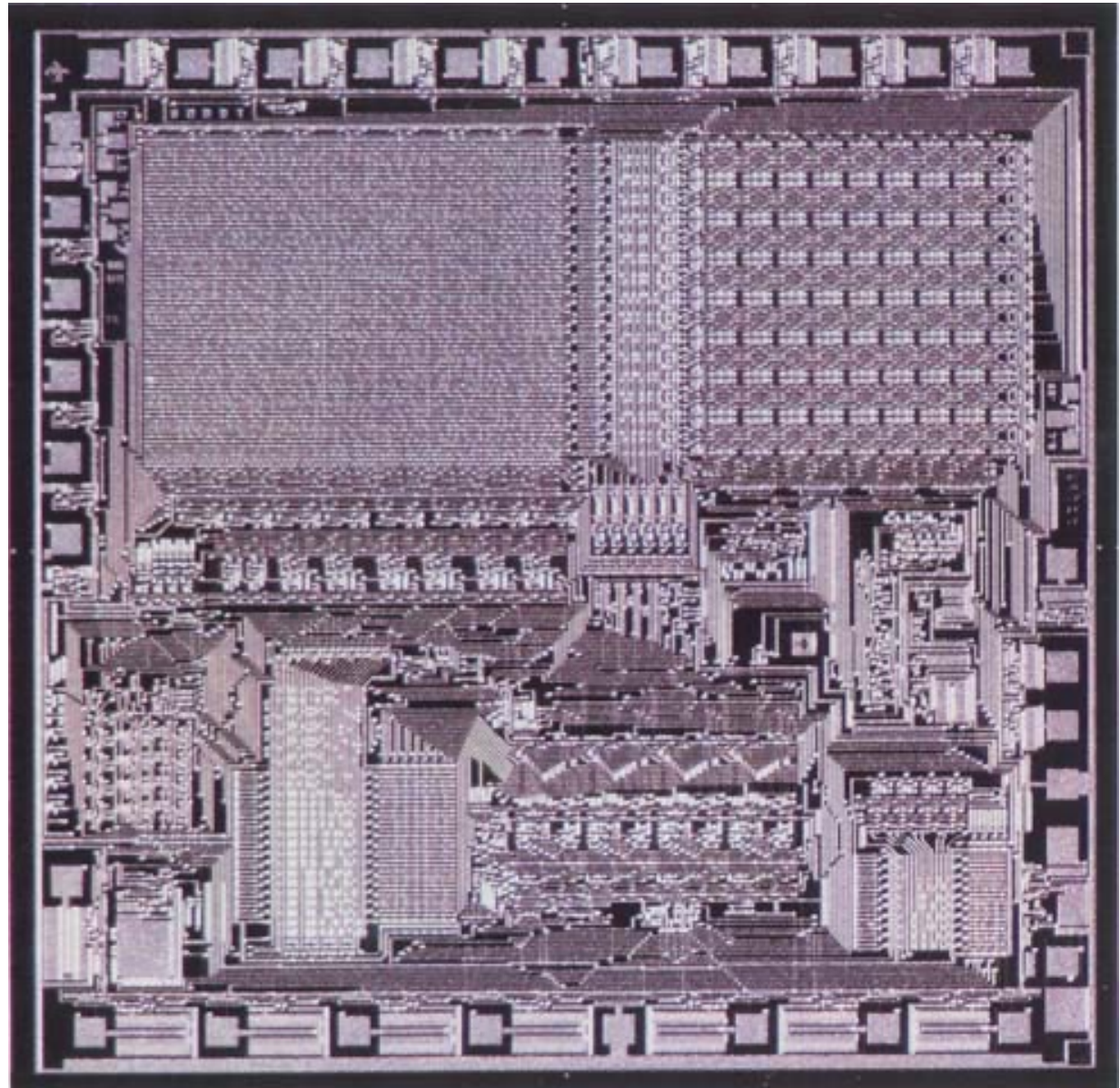

# 1974 – 8 bit DAC

- **Precision Monolithic DAC08**
- 140 ns Settling-Zeit
- Bipolar
- Wird noch hergestellt.
- 1.6 mm x 2.2 mm

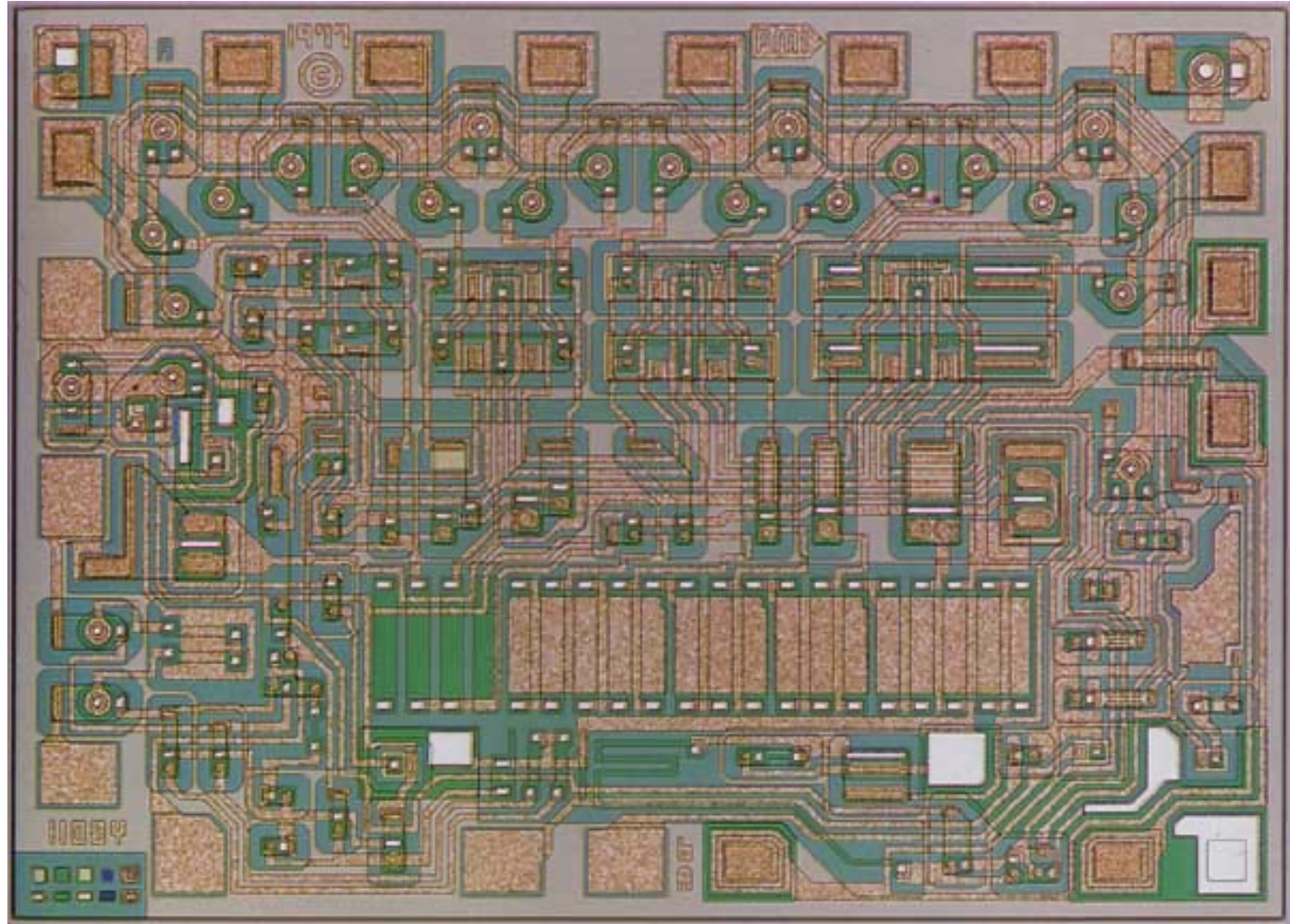



# 1975 – Ein schneller Prozessor

- **AMD** Advanced Micro Devices
- Bit Slice Prozessor 2901 (4bit)  
Mehrere Prozessoren arbeiten gleichzeitig an einem breiteren Datenwort.
- Bipolare Transistoren ⇒
  - sehr hoher Stromverbrauch
  - aber sehr schnell, verglichen mit dem CMOS der Zeit.
- 10 MHz Takt

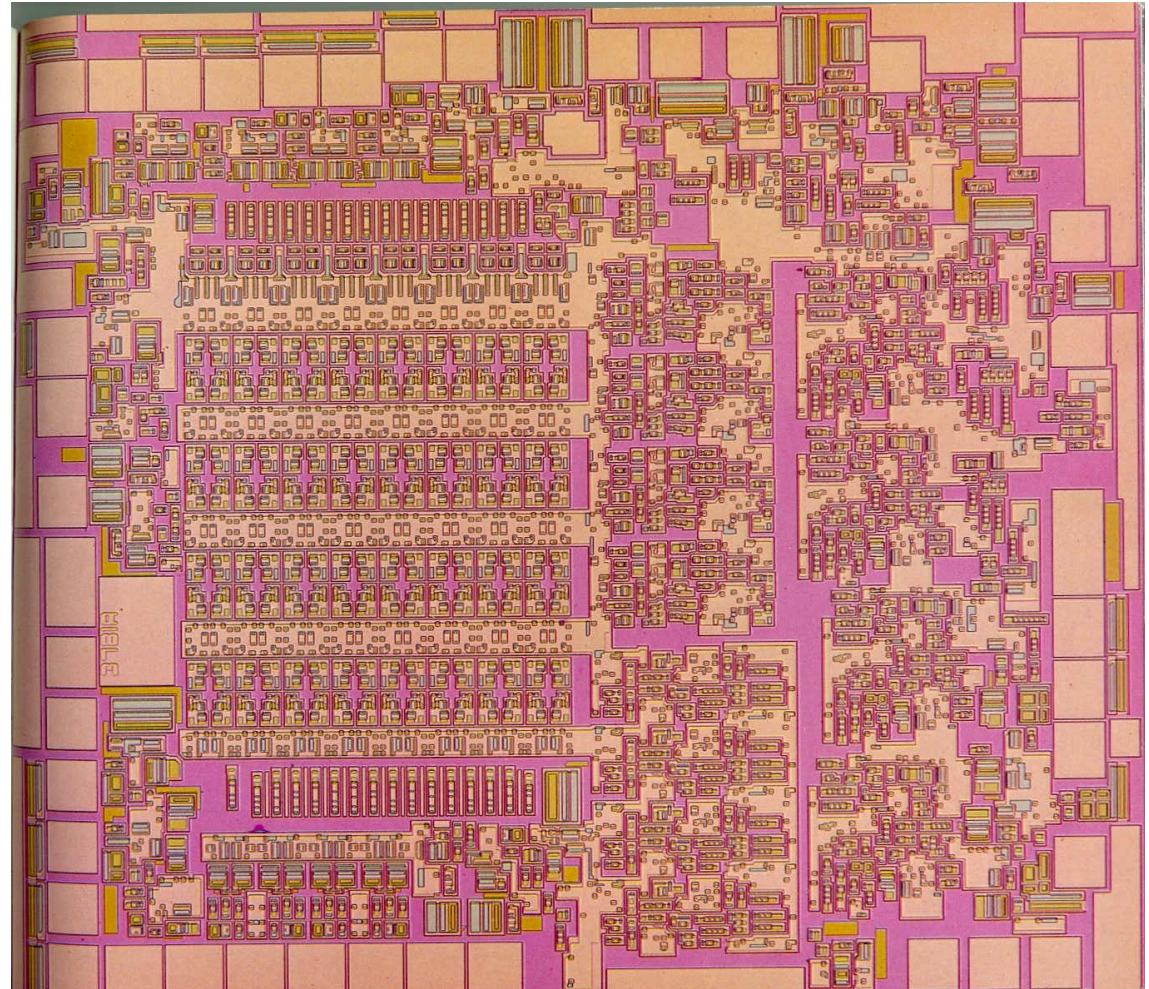



# 1976 – Z80

---

- **ZILOG**
- Gegründet von Intel Mitarbeitern Faggin (4004), Shima (8080) und anderen.
- Shockley ⇒ Fairchild ⇒ Intel ⇒ Zilog
- Verwandt mit 8080

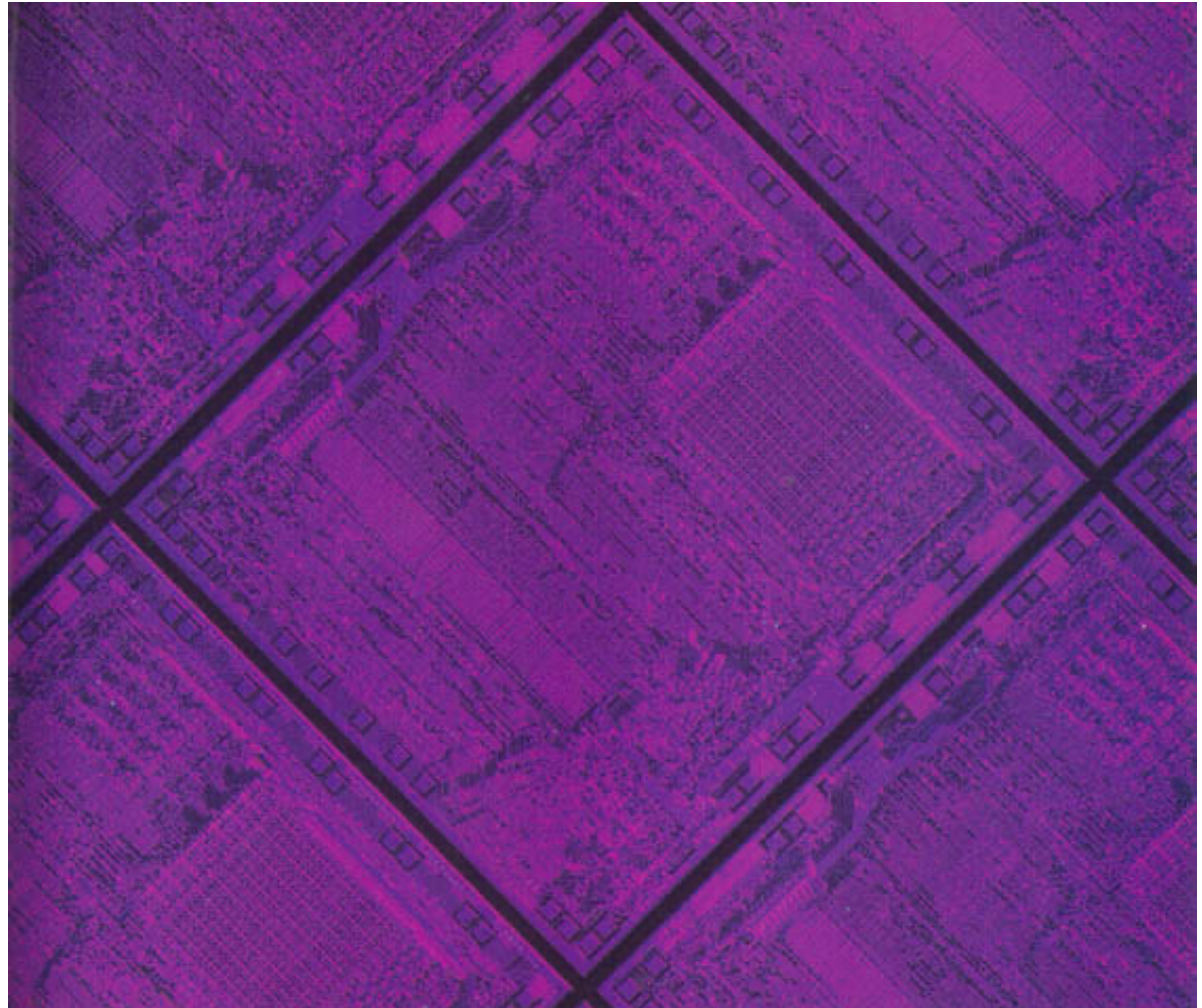

# 1977 – Programmable Array Logic

- **MMI**
- (**M**onolithic **M**emories **I**nc.)
- Programmierbare Logik  
(mit Fuses)
- Hier PAL16L8

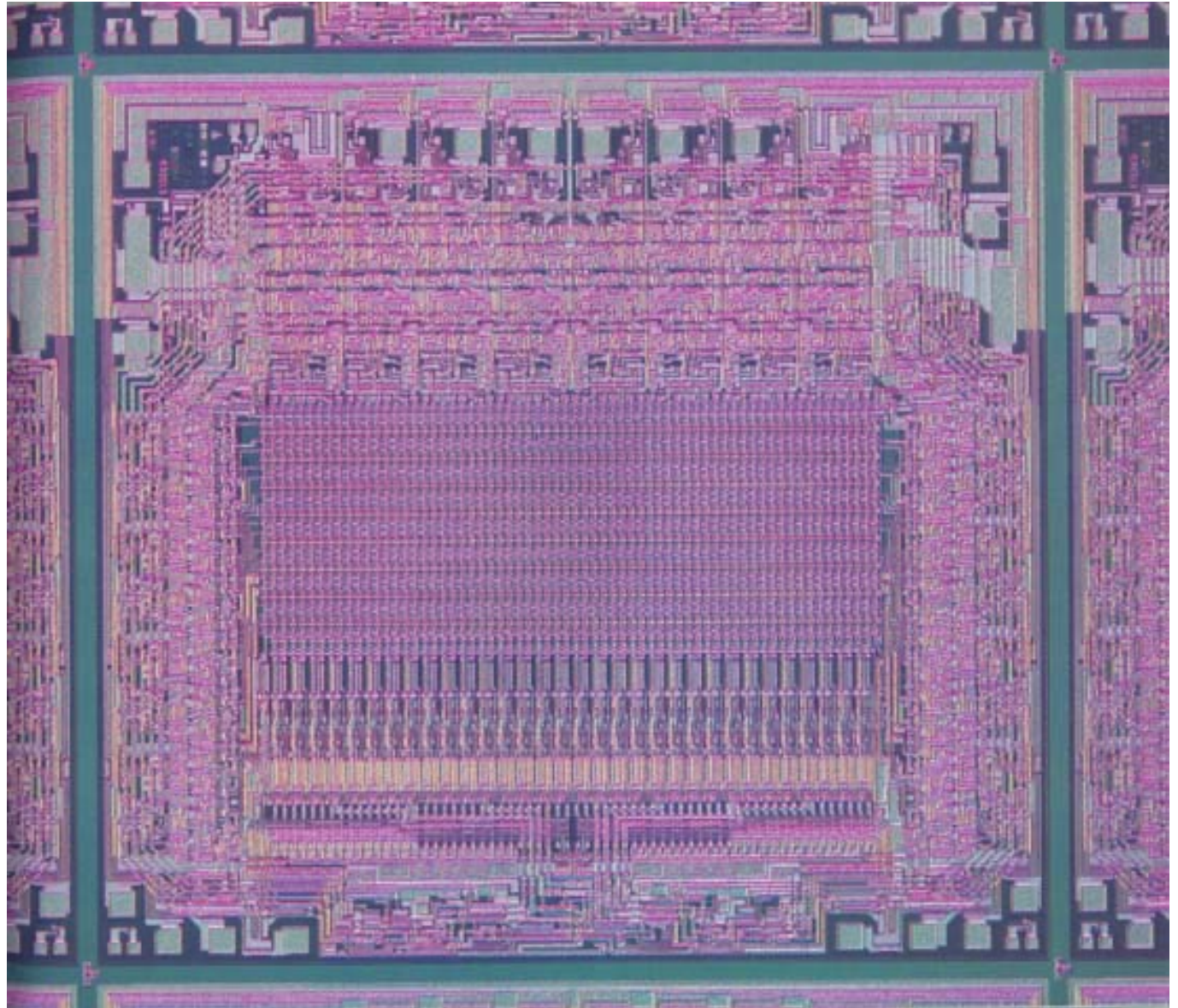



# 1977 – 65,536 Bit dynamisches RAM

- **IBM Corporation**  
(**I**nternational **B**usines **M**achines)
- IBM steigt relativ spät ins Chip-Geschäft ein
- ICs zunächst nur in den eigenen Produkten
- Seht innovativ:
  - Speicher Chips mit **Redundanz!**
  - Bump Bonds

Bump bonds

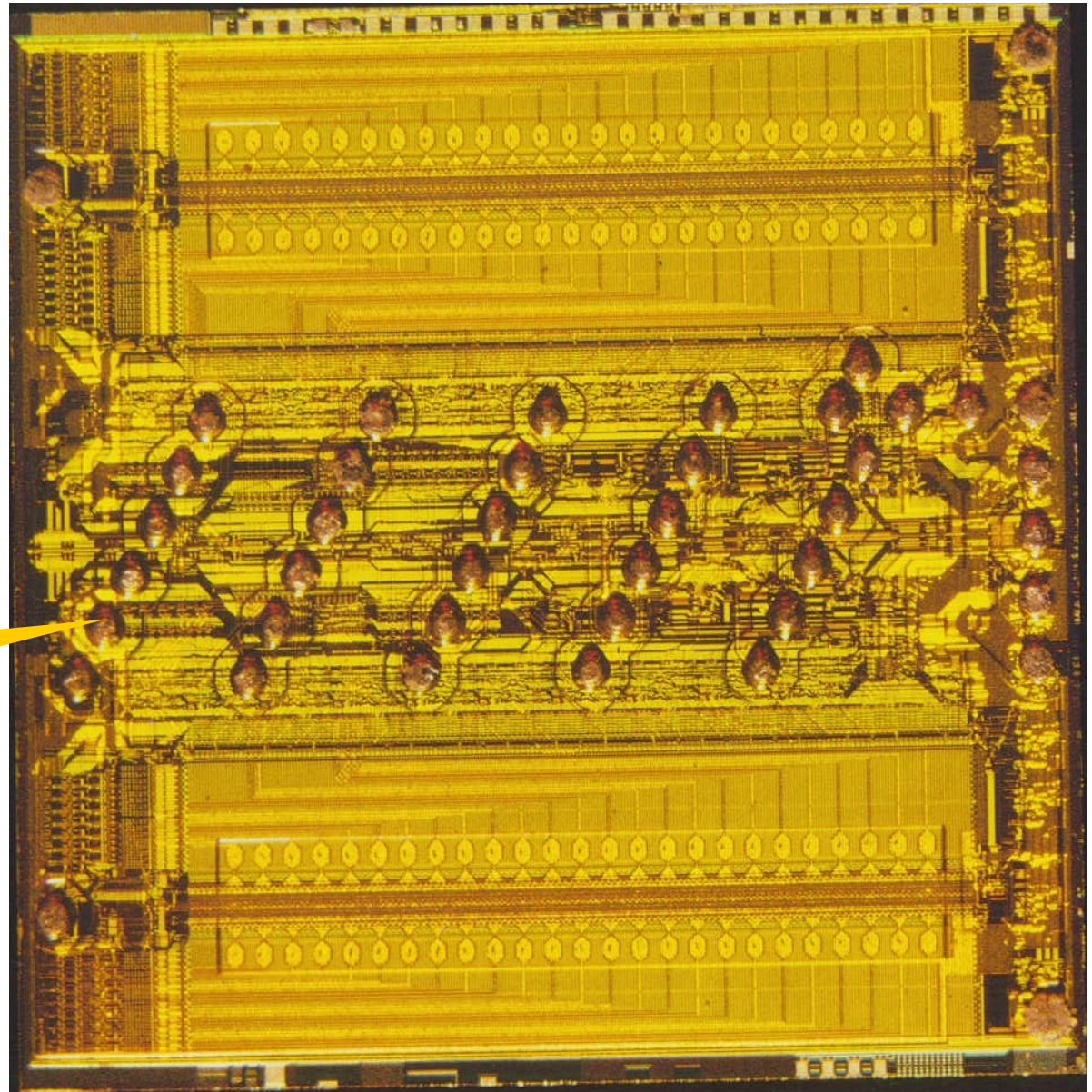



# 1979 – 16 Bit

- The **Motorola** 68000
- Large Scale Integration
- NMOS Transistoren
- 16 bit,  
kann 32 bit emulieren.
- Multiplizierer auf dem  
Chip, dadurch 50 x  
schneller in der  
Multiplikation wie der  
8080.

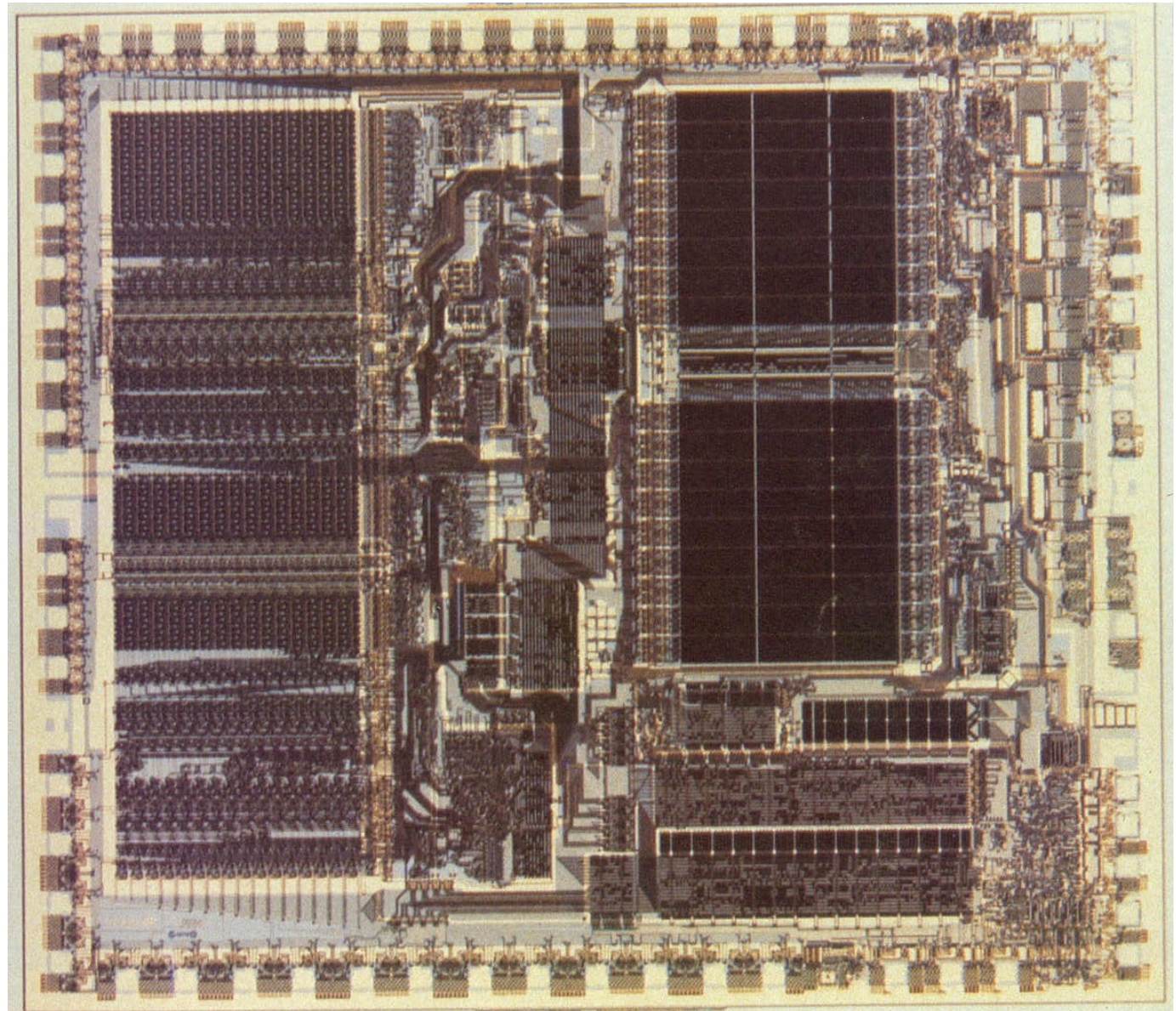



# 1980 (!) – Die optische Maus

- **XEROX**
- 16 optische Detektoren erkennen die Bewegung des beleuchteten Untergrundes

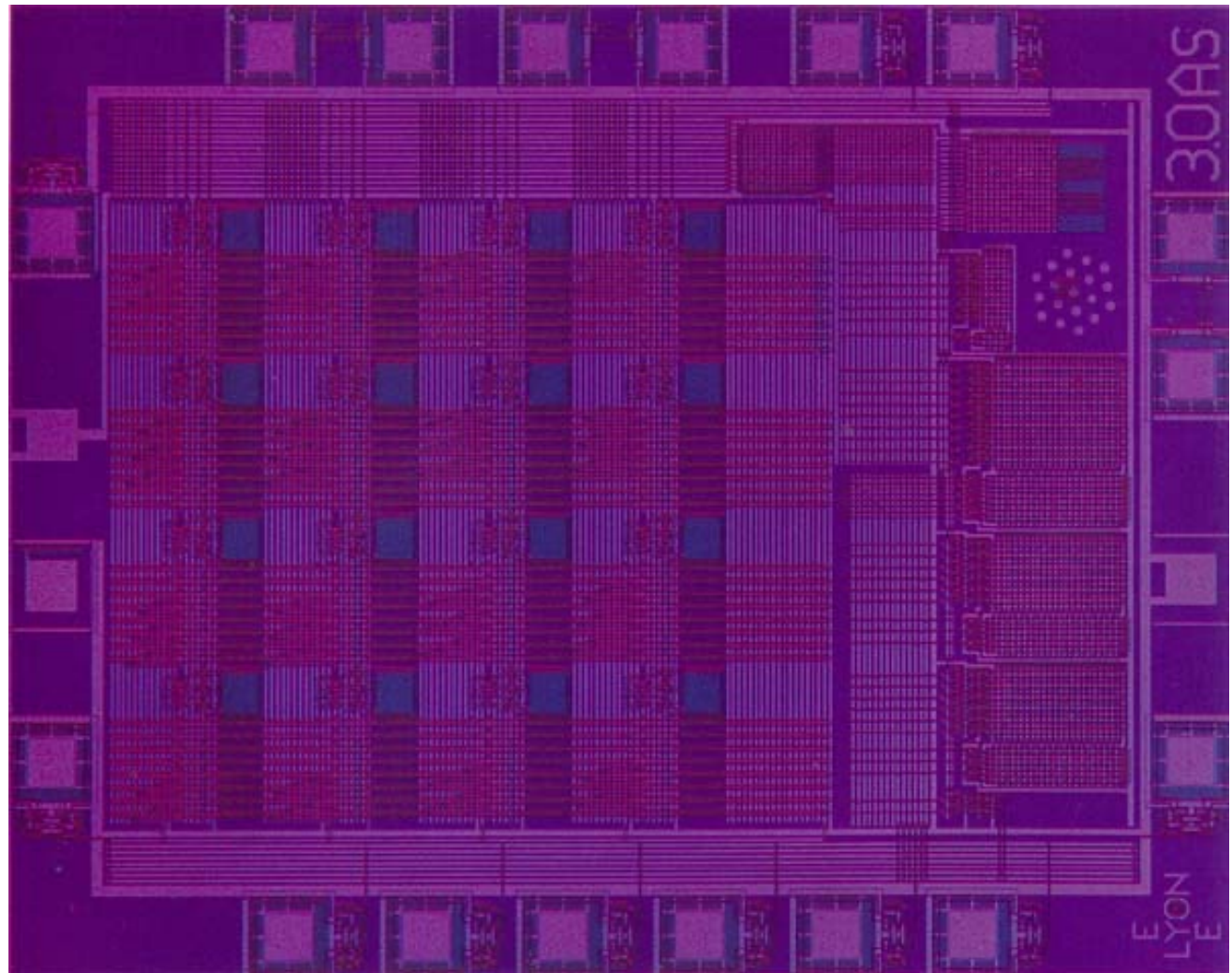

# 1982 – Intel 80286

- 6 MHz – 12 MHz
- 16 bit
- 120.000 Transistoren
- 1.5 $\mu$ m Technologie

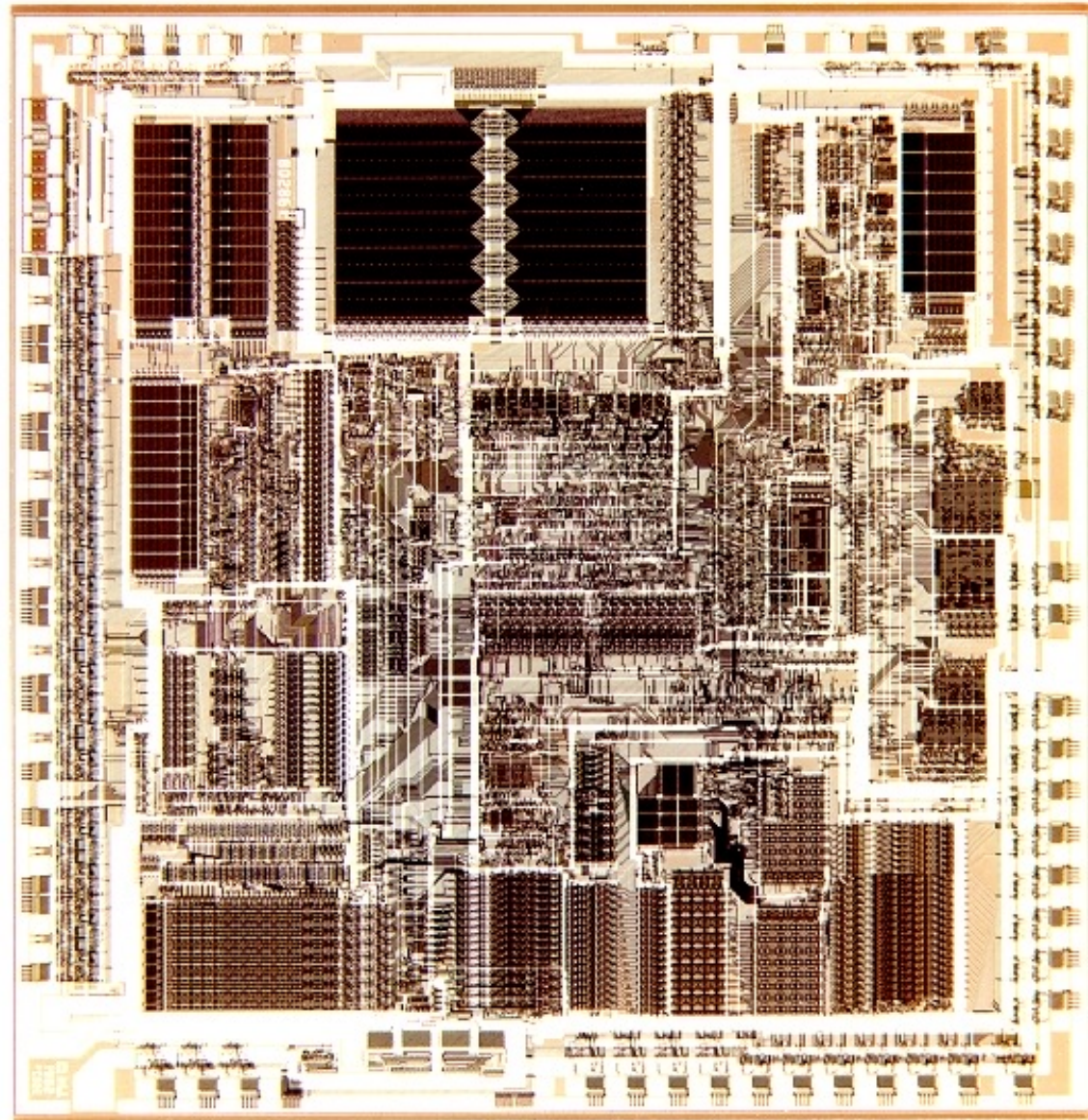



# 1993 – Intel Pentium

- 60 MHz
- 32 bit
- 3.1 Millionen Transistoren
- 0.8  $\mu\text{m}$  Technologie

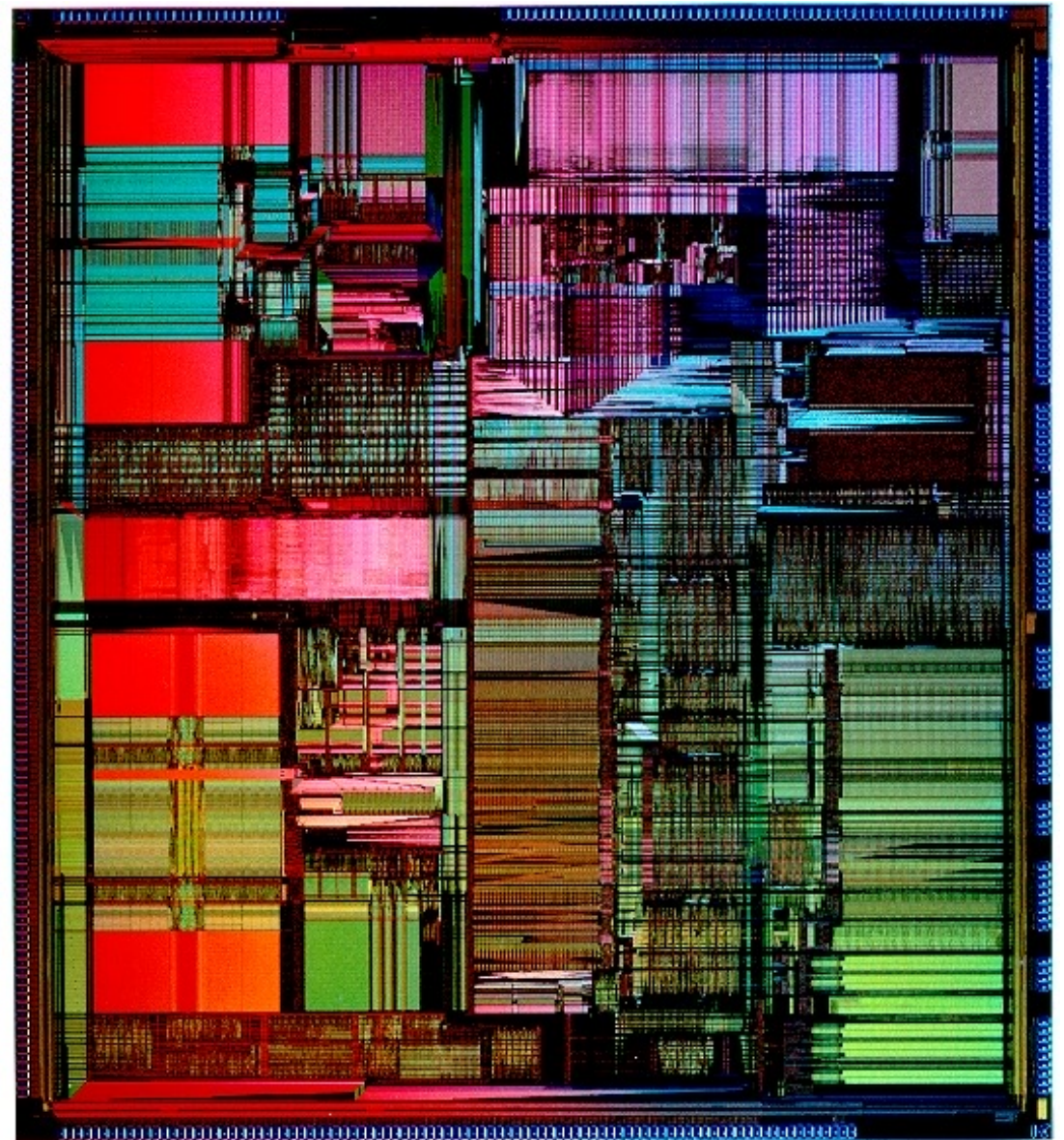
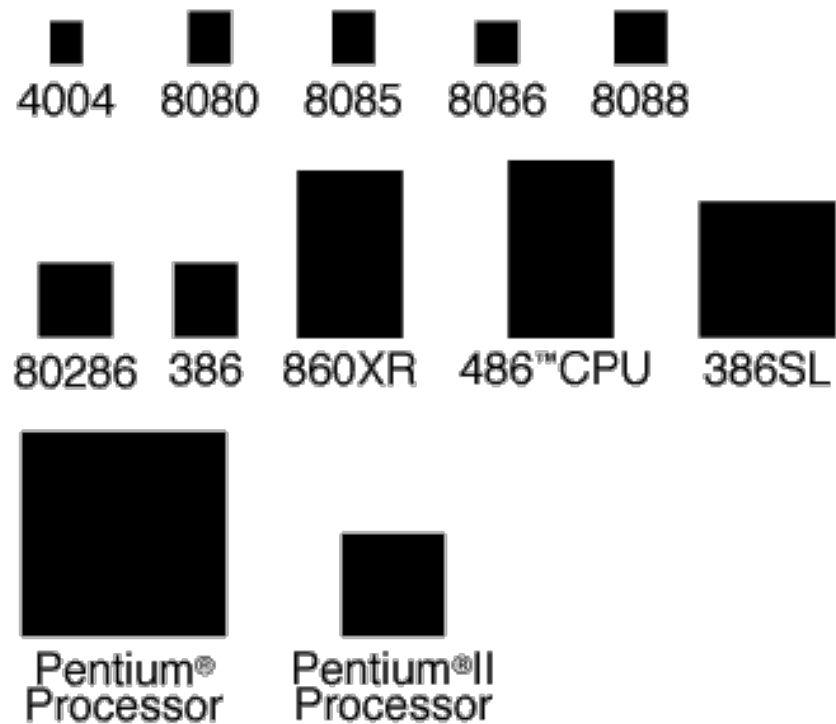



# 2000 – Intel Pentium (IV)

- 1.5 GHz
- 42 Millionen Transistoren
- 0.18  $\mu\text{m}$  Technologie

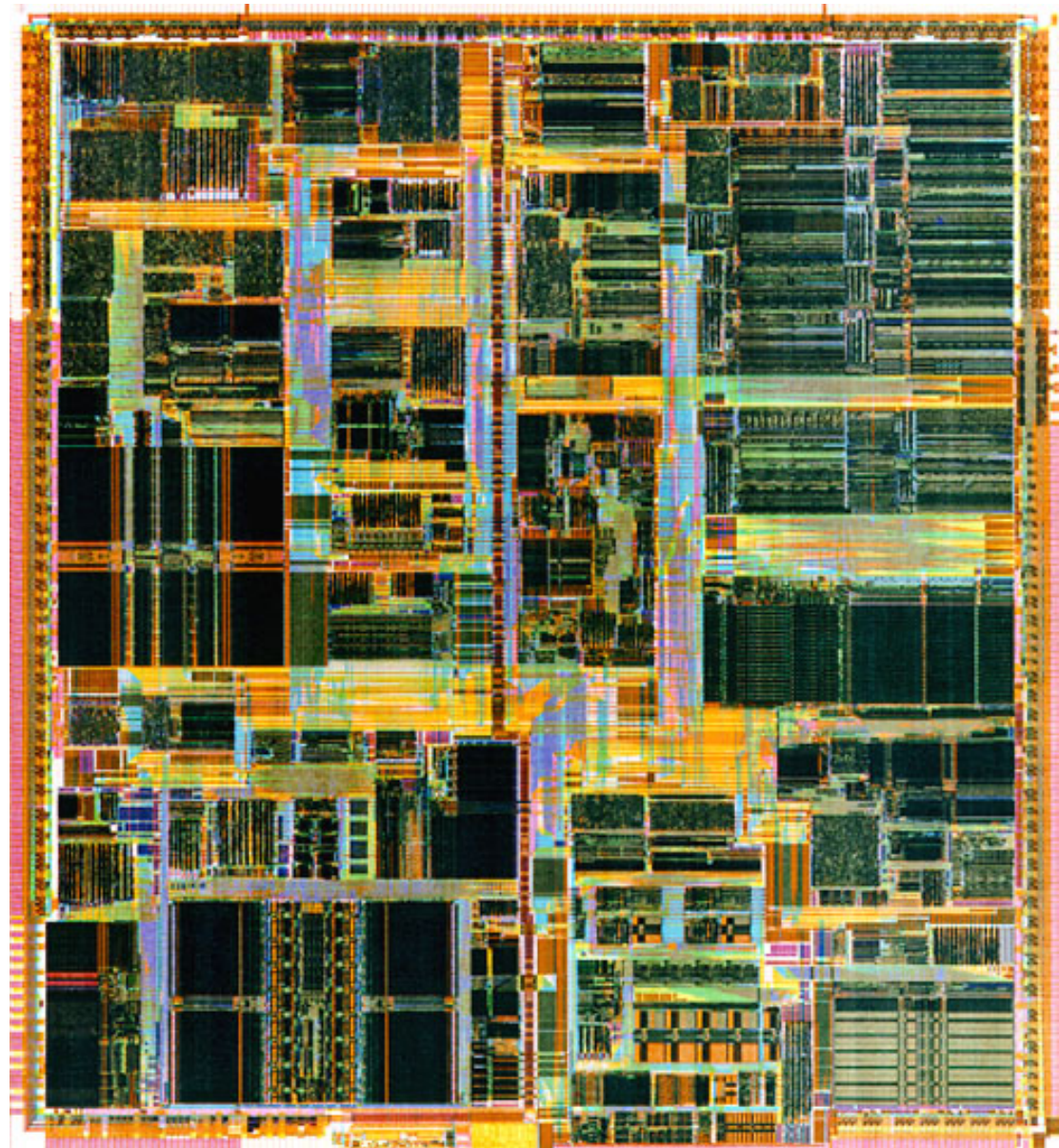



# Neue Märkte

- Handys, Smart-Phones, Tablets, Wearables,...



# Chips in der Forschung: Der ATLAS Front End Chip

- Größe Chip: 7.4mm x 11mm
- Pixels: 18 x 160 = 2880
- Größe Pixel: 50µm x 400µm
- Technologien: 0.8µm CMOS (FEA,FEB)  
0.8µm BiCMOS (FED)  
0.25µm CMOS (FEI)
  
- 2880 ladungsempfindliche Vorverstärker (nur 40µW / Pixel)
- Nullen-Unterdrückung in jedem Pixel
- Daten werden gepuffert bis ein Trigger sie anfordert.
- Serielle Ansteuerung, LVDS IO

